



# User manual

## MeasureEffect

Sonel measurement platform



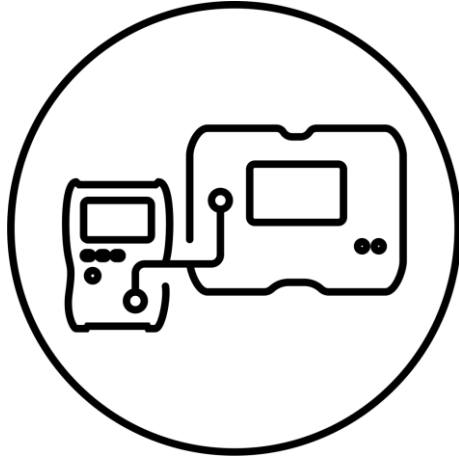

**User manual**

# **MeasureEffect**

Sonel measurement platform

**SONEL S.A.**  
Wokulskiego 11  
58-100 Świdnica  
Poland

Version 3.03 24.01.2025

MeasureEffect™

Welcome to the **Sonel MeasureEffect™** platform. It is a comprehensive system that enables you to take measurements, store and manage data, and provides multi-level control of your instruments.

In this document, we have described all the functions of the platform. Your meter's functionalities may be narrower.

# CONTENTS

<b>1</b>	<b>Interface and configuration</b>	<b>6</b>
1.1	On-screen keyboard	6
1.2	Menu icons	6
1.3	Gestures	7
1.4	User's account	7
1.4.1	Adding and editing users	8
1.4.2	Deleting users	8
1.4.3	Switching users	8
1.5	Configuration of the meter – main settings	9
1.5.1	Language	9
1.5.2	Date and time	9
1.5.3	Accessories	9
1.5.4	Meter	9
1.5.5	Measurements	10
1.5.6	Information	10
1.5.7	Factory reset of the meter	11
<b>2</b>	<b>First steps</b>	<b>12</b>
2.1	List of measurement functions	12
2.2	Live mode	12
2.3	Measurement settings	12
<b>3</b>	<b>Connections</b>	<b>13</b>
3.1	Electrical safety	13
3.1.1	Connections for EPA measurements	13
3.1.1.1	Point-to-point resistance – $R_{P1-P2}$	13
3.1.1.2	Point-to-ground resistance – $R_{P-G}$	14
3.1.1.3	Surface resistance – $R_{SUR}$	15
3.1.1.4	Volume resistance – $R_{VOL}$	16
3.1.2	Connections for $R_{ISO}$ measurements	17
3.1.3	Connections for $R_{ISO}$ measurements – measurements using the AutoISO-2511 adapter	20
3.1.4	Connections for $R_X$ , $R_{CONT}$ measurements	21
3.1.5	Connections for U measurements	21
3.2	Safety of electrical equipment	22
3.2.1	Connections for I measurements with clamp	22
3.2.2	Connections for $I_{\Delta}$ measurements with clamp	22
3.2.3	Connections for $I_{PE}$ measurements	23
3.2.4	Connections in measurements of devices in protection class I, $I_{\Delta}$ in the socket, $I_{SUB}$ , $R_{ISO}$	24
3.2.5	Connections in measurements of devices in protection class I and II, $I_{SUB}$ , $I_T$ , $R_{ISO}$	24
3.2.6	Connections for $R_{ISO}$ measurements	25
3.2.7	Connections for $R_{PE}$ measurements	26
3.2.8	Connections in measurements of IEC devices – $R_{ISO}$ , $R_{PE}$ , IEC	26
3.2.9	Connections in measurements of PRCD devices – $I_{\Delta}$ , $I_{PE}$ , $I_T$ , $R_{PE}$	27
3.2.10	Connections in measurements of PELV devices	27
3.2.11	Connections in the measurement of stationary RCDs	27
3.2.12	Connections in welding machine measurements	28
3.2.12.1	Single-phase welding machine – measurement of $I_L$ , $R_{ISO}$ , $U_0$	28
3.2.12.2	Single-phase welding machine – measurement of $I_P$	28
3.2.12.3	Single-phase welding machine – measurement of $I_P$ using PAT-3F-PE adapter	28
3.2.12.4	Single-phase or three-phase welding machine – measurement of $R_{ISO}$	29
3.2.12.5	Three-phase welding machine – measurement of $I_L$ , $U_0$	29
3.2.12.6	Three-phase welding machine – measurement of $I_P$ using PAT-3F-PE adapter	30

3.2.13	Connections – power test .....	31
<b>3.3</b>	<b>Photovoltaics .....</b>	<b>32</b>
3.3.1	Connections in diode tests – conduction direction (F) .....	32
3.3.2	Connections in the blocking diode tests – conduction direction (F), reverse direction (R) .....	32
3.3.3	Connections for I measurements .....	33
3.3.4	Connections for $I_{SC}$ , $U_{OC}$ , I-U measurements .....	33
3.3.5	Connections for P measurements .....	34
3.3.6	Connections for $R_{ISO}$ measurements .....	34
3.3.7	Connections for $R_{ISO}$ PV measurements .....	35
<b>4</b>	<b>Measurements. Visual test .....</b>	<b>36</b>
<b>5</b>	<b>Measurements. Electrical safety .....</b>	<b>37</b>
5.1	DD – Dielectric Discharge Indicator .....	37
5.2	EPA – measurements in the EPAs .....	39
5.3	RampTest – measurement with ramp test .....	41
5.4	$R_{ISO}$ – insulation resistance .....	43
5.4.1	Measurements with the use of test leads .....	43
5.4.2	Measurements using the AutoISO-2511 adapter .....	45
5.5	$R_{ISO}$ 60 s – Dielectric Absorption Ratio (DAR) .....	47
5.6	$R_{ISO}$ 600 s – Polarization Index (PI) .....	49
5.7	$R_X$ , $R_{CONT}$ – low-voltage measurement of resistance .....	51
5.7.1	Autozero – calibration of test leads .....	51
5.7.2	$R_X$ – measurement of resistance .....	51
5.7.3	$R_{CONT}$ – measurement of resistance of protective conductors and equipotential bonding with $\pm 200$ mA current .....	52
5.8	SPD – testing surge protecting devices .....	54
5.9	SV – measurements with a voltage increasing in steps .....	57
5.10	U – voltage .....	59
<b>6</b>	<b>Measurements. Safety of electrical equipment .....</b>	<b>60</b>
6.1	$I_{Clamp}$ – measurement of current with clamp .....	60
6.2	$I_{\Delta}$ – differential leakage current .....	62
6.3	$I_L$ – welding circuit leakage current .....	64
6.4	$I_P$ – welding machine power supply circuit leakage current .....	66
6.5	$I_{PE}$ – leakage current in the PE wire .....	68
6.6	$I_{SUB}$ – substitute leakage current .....	70
6.7	$I_T$ – touch leakage current .....	72
6.8	IEC – IEC cord test .....	74
6.9	PELV – test of PELV appliances .....	76
6.10	PRCD – testing PRCD devices (with built-in RCD) .....	78
6.11	RCD – measurement of fixed RCD parameters .....	80
6.12	$R_{ISO}$ – insulation resistance .....	82
6.13	$R_{ISO LN-S}$ , $R_{ISO PE-S}$ – insulation resistance in welding machines .....	84
6.14	$R_{PE}$ – protective conductor resistance .....	86
6.14.1	Autozero – calibration of test leads .....	86
6.14.2	$R_{PE}$ – protective conductor resistance .....	87
6.15	$U_0$ – welding machine voltage without load .....	89
6.16	Functional test .....	91
<b>7</b>	<b>Measurements. Photovoltaics .....</b>	<b>93</b>
7.1	Diode test .....	93
7.2	I-U – I-U curve .....	95
7.3	$I_{Clamp}$ – current clamp measurement .....	97

7.4	I <sub>SC</sub> – DC short circuit current .....	98
7.5	P – power measurement .....	100
7.6	R <sub>ISO</sub> – insulation resistance .....	101
7.7	R <sub>ISO</sub> PV – insulation resistance in PV systems .....	103
7.8	U <sub>OC</sub> – DC voltage of open circuit .....	105
<b>8</b>	<b>Automatical tests .....</b>	<b>107</b>
8.1	Performing automatic measurements .....	107
8.2	Creating measurement procedures .....	109
8.3	Multibox function.....	109
8.4	Guidelines.....	110
8.4.1	Photovoltaics (DC).....	110
<b>9</b>	<b>Special features .....</b>	<b>111</b>
9.1	R <sub>ISO</sub> graphs .....	111
9.2	Correcting the R <sub>ISO</sub> value to the reference temperature .....	113
9.2.1	Correction without the temperature probe.....	113
9.2.2	Correction with the temperature probe.....	114
9.3	Correction of results to STC .....	116
9.3.1	Connectivity between IRM-1 and the meter .....	116
9.3.2	Pairing the meters.....	116
9.3.3	Unpairing.....	117
9.3.4	Correction of IRM indications .....	118
9.4	Current readings of environmental parameters.....	119
9.5	Label printing .....	120
9.5.1	Connecting the printer .....	120
9.5.1.1	Wire connection .....	120
9.5.1.2	Wireless connection .....	120
9.5.2	Printing settings .....	121
9.5.3	Printing a label with the report .....	123
<b>10</b>	<b>Resources.....</b>	<b>124</b>
10.1	Photovoltaic panels database .....	124
<b>11</b>	<b>Memory of the meter.....</b>	<b>125</b>
11.1	Memory structure and management .....	125
11.2	Search function.....	125
11.3	Saving measurement result data to the memory.....	126
11.3.1	From the measurement result to the object in memory .....	126
11.3.2	From the object in memory to the measurement result .....	126
<b>12</b>	<b>Software update.....</b>	<b>127</b>
<b>13</b>	<b>Troubleshooting.....</b>	<b>128</b>
<b>14</b>	<b>Additional information displayed by the meter.....</b>	<b>129</b>
14.1	Electrical safety .....	129
14.2	Safety of electrical equipment .....	129
14.3	Photovoltaics .....	130
<b>15</b>	<b>Manufacturer .....</b>	<b>132</b>

# 1 Interface and configuration

## 1.1 On-screen keyboard

The on-screen keyboard has the same functions as the keyboard on any touchscreen device.









-  Delete
-  Go to new line
-  Go to the next field
-  Switch to a keyboard with numbers and special characters
-  Show diacritics
-  Confirm the entered text
-  Hide the keyboard

## 1.2 Menu icons







### General

-  Go to the previous window
-  Return to the main menu
-  Help
-  Log out the user
-  Expand the item
-  Collapse the item
-  Save
-  Close window / cancel the action
-  Information

### Measurements

-  Enter the markings
-  Add a measurement object
-  Measurement settings and limits
-  Start the measurement
-  Finish the measurement
-  Repeat the measurement
-  Show the graph

### Memory

-  Add an object
-  Add a folder
-  Add an instrument
-  Add a measurement
-  Search
-  Go to the parent folder



## 1.3 Gestures



Start the measurement by holding the icon for 5 seconds



Touch an item on the touch screen

## 1.4 User's account

After logging in, you will gain access to the user accounts menu. The padlock symbol means that the user is protected by a password.



Users are introduced to a list of people, who performed tests using their signature name. The device can be used by a number of people. Every person can log in as a user with their own login and password. Passwords are used to prevent logging into another users account. Only the **administrator** has the right to enter and delete users. **Other users** can only change their own data.



- The meter can have only one administrator (admin) and a maximum of 4 users with limited rights.
- The user created by the administrator receives their own meter settings.
- These settings can only be changed by that user and the administrator.

## 1.4.1 Adding and editing users

1

- To enter a new user, select .
- To change the data of a given user, select the user.
- Then enter or edit its data.

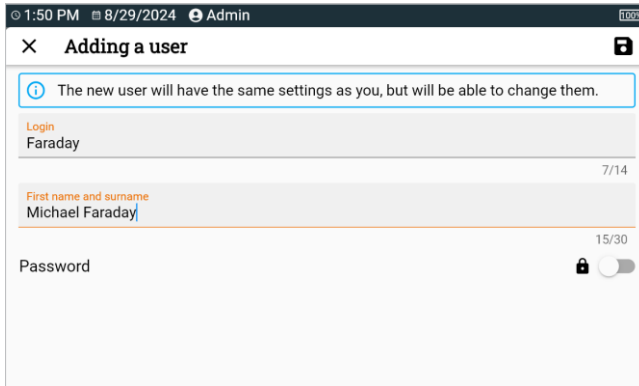

2



After touching the padlock, you can enter the password to access the user account. Touch it again if you want to disable the account password protection.

3



Finally, save your changes.

## 1.4.2 Deleting users

To delete users, mark them and select . The exception is the administrator account, which can only be deleted by restoring the meter to the factory settings (**sec. 1.5.4**).

## 1.4.3 Switching users

1



To change the user, log out the current user and confirm the ending of the session.

2



Now you can log in as another user.

## 1.5 Configuration of the meter – main settings



Here you can configure the meter to your needs.

### 1.5.1 Language



Here you can set the interface language.

### 1.5.2 Date and time



Available settings:

- **Date.**
- **Time.**
- **Time zone.**

### 1.5.3 Accessories



Here you will find a list of accessories and their configuration options.

### 1.5.4 Meter



Available settings:

- **Communication** – here you can configure the available communication methods.
- **Display** – here you can turn on/off the time for when the screen will turn off, adjust the brightness, turn on/off the touch function of the screen, change the size of fonts and icons in the measurement view.
- **Auto off** – here you can set/disable the Auto OFF time of the device.
- **Sounds** – here you can turn on/off the system sounds.
- **Update** – here you can update the device software.
- **Specialized mode** – allows you to enter a special service code. This functionality is dedicated to our technical support.
- **Recovery** – here you can restore the meter to factory settings. See also **sec. 1.5.7**.
- **Meter status** – here you can check the used and available space in the internal memory.

## 1.5.5 Measurements



Available settings:

- **Mains type** – type of network to which the device is connected.
- **Mains frequency** – voltage frequency of the network to which the device is connected.
- **Mains voltage** – voltage of the network to which the device is connected.
- **Enable high voltage warnings** – displaying additional messages about high voltage while taking measurements.
- **Show dangerous voltage warning** – displaying a warning about high voltage occurring during measurement.
- **Allow reverse polarity IEC L-N** – allowing interchanged L and N wires of an IEC cable.
- **Measurement acquisition delay** – here you can set the delay for starting the measurement.
- **Delayed start of the tested device** – here you can set the delay for starting the tested device when testing its security.
- **Visual test with R L-N** – when the option is active, the meter checks the internal resistance of the object connected to it for e.g. short circuit.
- **Enable warning of unconnected appliance** – when the option is active, the meter checks whether the tested device is connected to it.
- **ID auto increment** – creating new memory items with a unique ID for the parent folder in sequential numbering.
- **Name auto increment** – creating new memory items according to previously selected names and types.
- **Temperature unit** – setting the unit of temperature displayed and stored in the result after connecting the temperature probe.

## 1.5.6 Information



Here you can check information about the meter.

## 1.5.7 Factory reset of the meter



You have several options in this menu.

- **Meter memory optimization.** Use this function, if:
  - ⇒ there are problems with saving or reading measurements,
  - ⇒ there are problems navigating through folders.If this method does not correct the problem, use the "Reset the meter's memory" function.
- **Resetting the meter's memory.** Use this function, if:
  - ⇒ restoring the meters memory did not correct the problem.
  - ⇒ there are other problems preventing the use of the memoryBefore starting the deletion, we recommend that you transfer the data to a USB stick or a computer.
- **Factory reset of the meter.** All saved folders, measurements, user accounts and entered settings will be deleted.

After selecting the desired option, confirm your decision and follow the prompts.

## 2 First steps





### 2.1 List of measurement functions

The list of available measurement functions varies depending on what is connected to the device.

- By default, functions that do not require a power supply are displayed.
- After connecting the power supply, the list of functions may expand.
- After connecting the AutoISO adapter, the list of available measurement functions will be narrowed down to those dedicated to the adapter.

### 2.2 Live mode

In some functions you can view the values read by the meter in a given measurement system.

-  Select measurement **function**.
-  Select the icon to expand/minimize the live readings panel.
-  Touching the panel expands it to full size. In this form, it presents additional information. You can close it with the  icon.

### 2.3 Measurement settings

- +/-** In the measurement menu, you can enter or edit the markings of wire pairs in the tested object. The names (marking) may be:
- predefined,
  - defined by user (after selecting **Use your own wire markings**).

**+/-**  
**L1/L2**  
... The label icons lead to the labelling window of a pair of lines. The new markings cannot be the same as those already introduced.



 The icon opens the window for adding the measurement of the next pair of conductors.



Tests require appropriate settings. To do this, select this icon in the measurement window. A menu will open with parameter settings (different items depend on the selected measurement).



If you have set limits, the meter will show if the result are within them.

-  – the result is within the set limit.
-  – the result is outside the set limit.
-  – assessment not possible.

# 3 Connections

## 3.1 Electrical safety

### 3.1.1 Connections for EPA measurements

The connection layouts vary depending on what you want to measure.

#### 3.1.1.1 Point-to-point resistance – $R_{P1-P2}$

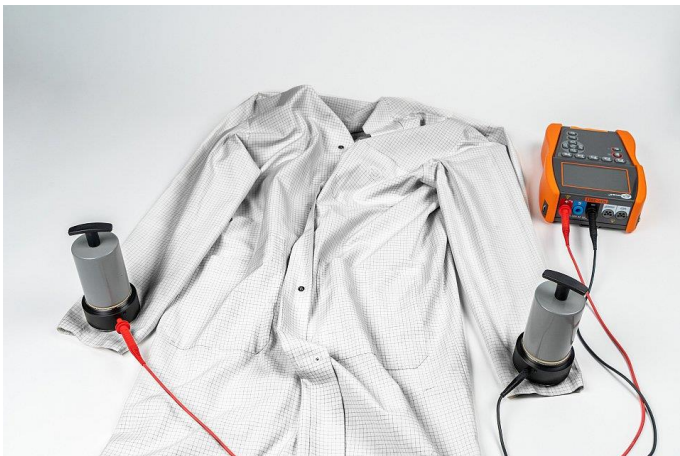
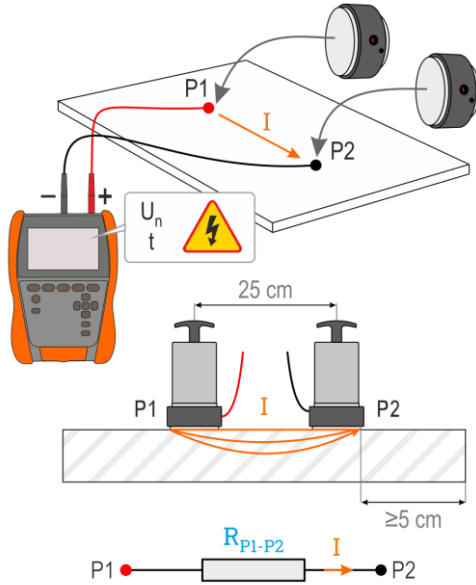

### 3.1.1.2 Point-to-ground resistance – $R_{P-G}$

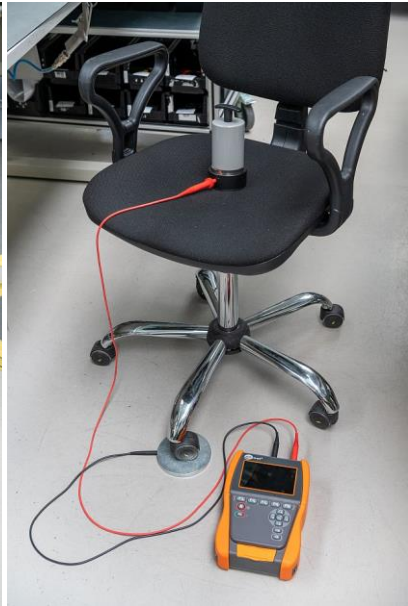
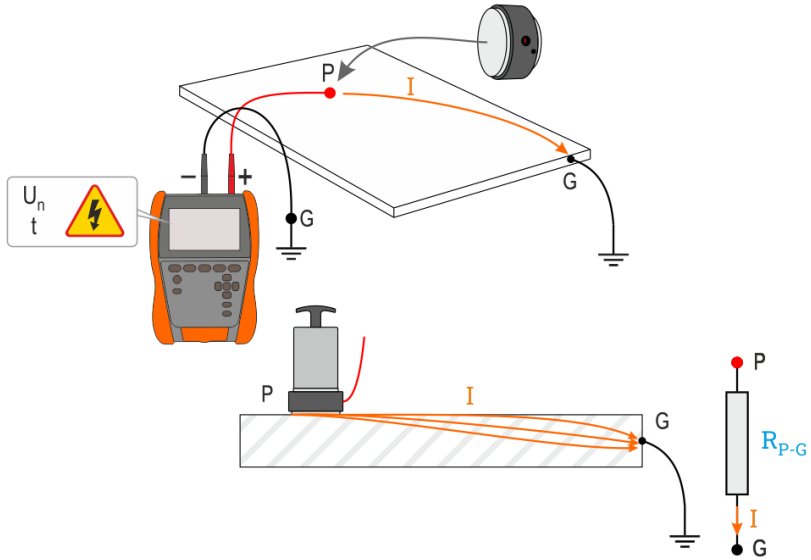



### 3.1.1.3 Surface resistance – $R_{SUR}$

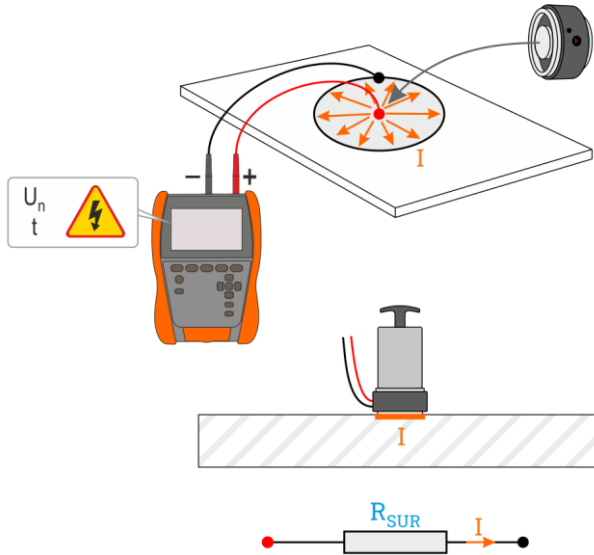

### 3.1.1.4 Volume resistance – $R_{VOL}$

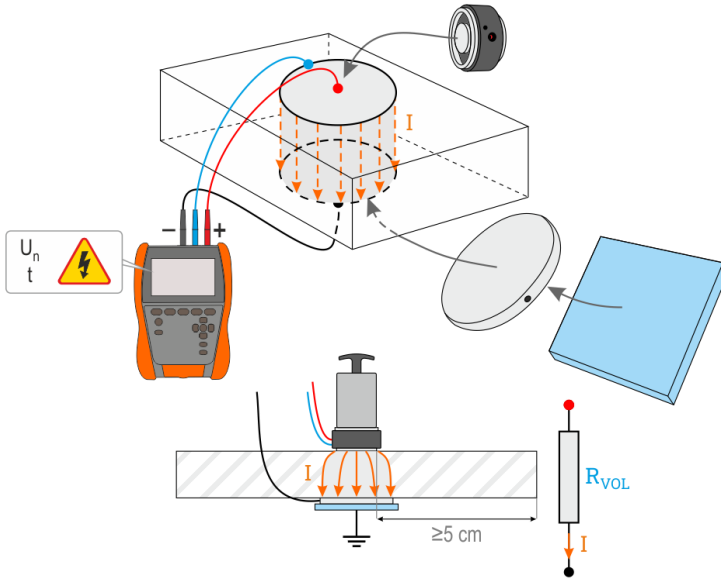

### 3.1.2 Connections for $R_{ISO}$ measurements



During the measurement, **make sure that test leads and crocodile clips do not touch each other and/or ground**, because such a contact may cause the flow of surface currents resulting in additional error in measurement results.

The standard way of measuring the insulation resistance ( $R_{ISO}$ ) is the two-lead method.

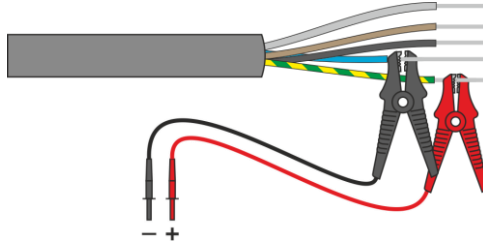

In case of power cables measure the insulation resistance between each conductor and other conductors shorted and grounded (**Fig. 3.1** , **Fig. 3.2**). In shielded cables, the shield is also shorted.

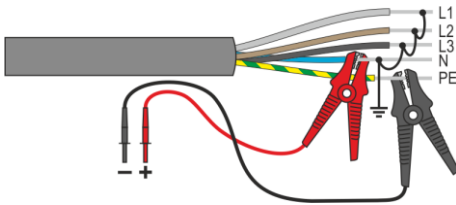

Fig. 3.1. Measurement of an unshielded cable

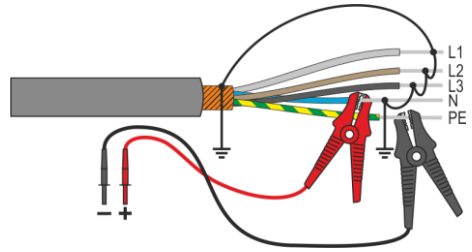
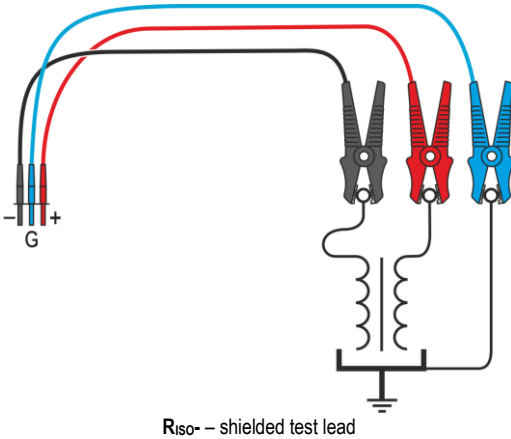
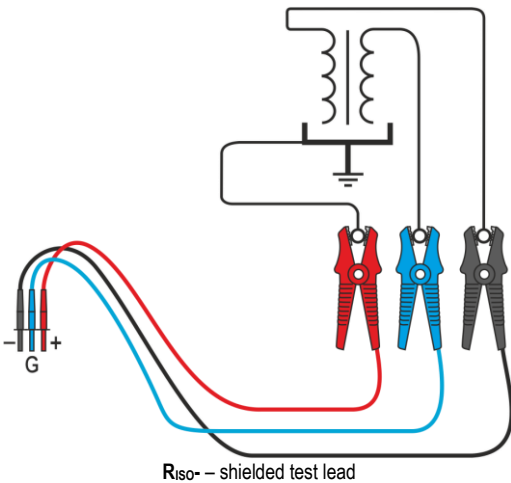

Fig. 3.2. Measurement of a shielded cable

In transformers, cables, insulators, etc. there is **surface resistance** that can distort the measurement result. To **eliminate** it, a three-lead measurement with **G – GUARD** socket is used. An example of the application of this method is presented below.



**Measurement of inter-winding resistance of a transformer.** Connect **G** socket to the transformer tank, and **R<sub>ISO+</sub>** and **R<sub>ISO-</sub>** sockets to the windings.



**Measurement of insulation resistance between one of the windings and the transformer tank.** **G** socket of the meter should be connected to the second winding, and **R<sub>ISO+</sub>** socket to the ground potential.

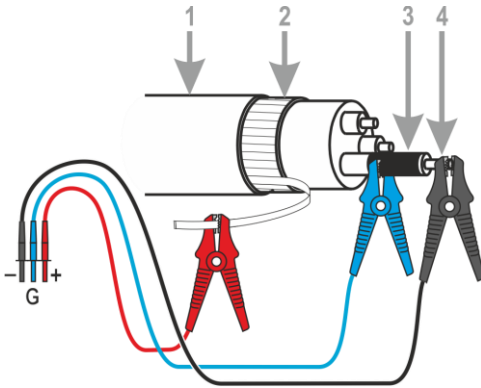

R<sub>ISO</sub>- – shielded test lead

1 – cable jacket

2 – cable shield

3 – metal foil wrapped around conductor's insulation

4 – conductor

**Measurement of cable insulation resistance between one of cable conductors and its shield.** The effect of surface currents (important in adverse weather conditions) is eliminated by connecting a piece of metal foil insulating the tested conductor with **G** socket of the meter.

The same shall apply when measuring the insulation resistance between two conductors of the cable - other conductors that do not take part in the measurement are attached to **G** terminal.

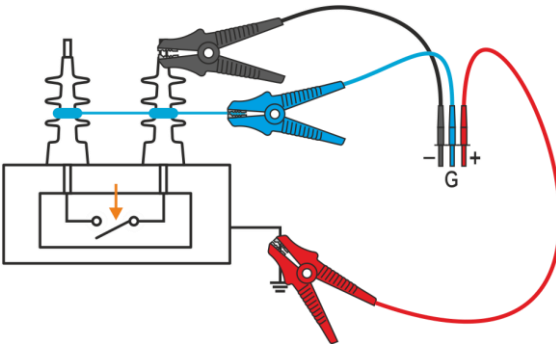

R<sub>ISO</sub>- – shielded test lead

**Insulation resistance measurement of high voltage breaker.** **G** socket of the meter is connected with the insulators of disconnector terminals.

### 3.1.3 Connections for $R_{ISO}$ measurements – measurements using the AutoISO-2511 adapter

Depending on the measurement facility and the established standards (each conductor to each or conductor to other shorted and grounded conductors), the measurement of the insulation resistance of wires or multi-core cables requires several connections. In order to shorten the measurement time and eliminate the inevitable connection errors, Sonel recommends an adapter that switches between individual pairs of conductors for the operator.

The AutoISO-2511 adapter is designed to measure the insulation resistance of cables and multi-core wires with a measuring voltage of up to 2500 V. The use of the adapter eliminates the possibility of making a mistake, and significantly reduces the time needed to measure the insulation resistance between pairs of conductors. For example, for 4-core cables, the user will perform only one connection operation (i.e. connect the adapter to the facility), while the AutoISO-2511 will perform the crossing for six consecutive connections.

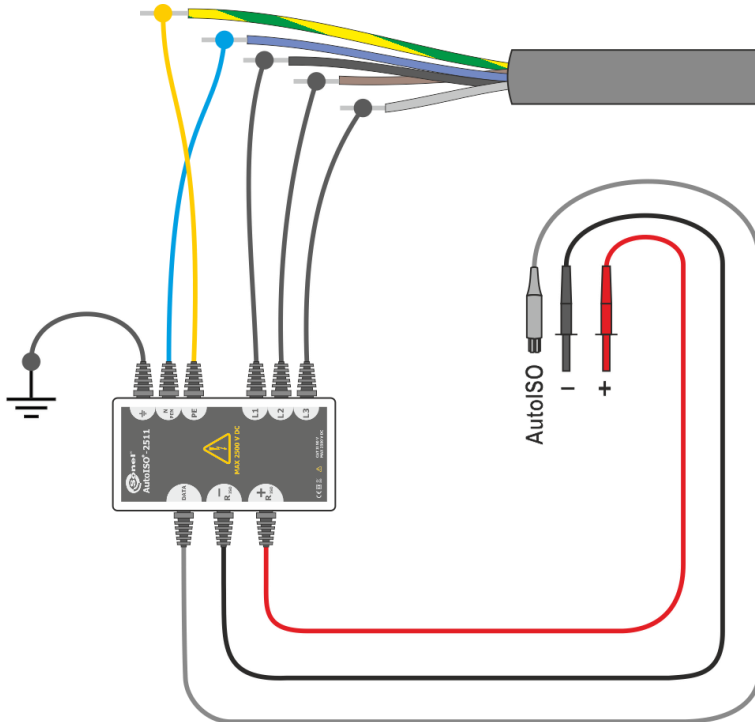

### 3.1.4 Connections for $R_x$ , $R_{CONT}$ measurements

Low-voltage measurement of resistance is carried out in one of the following circuits, depending on the available meter sockets.

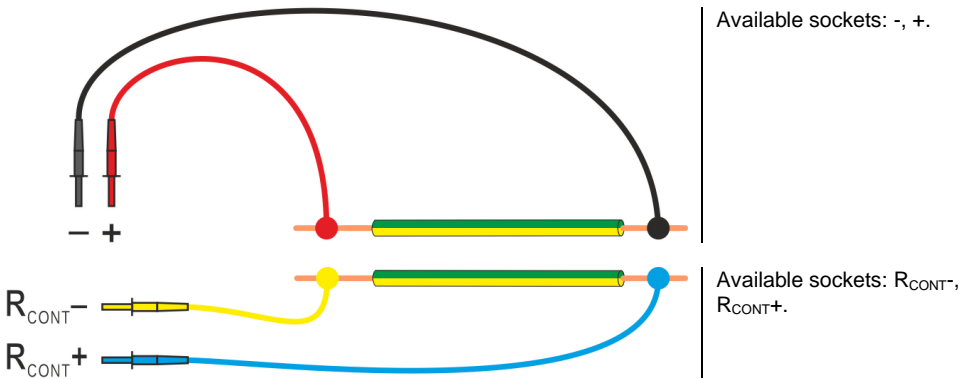

### 3.1.5 Connections for U measurements

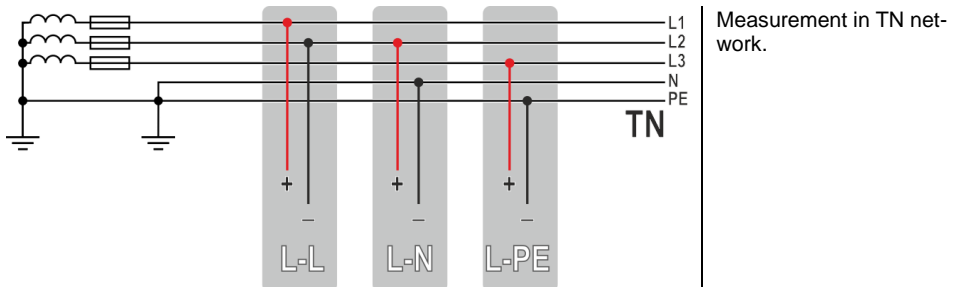

## 3.2 Safety of electrical equipment

### 3.2.1 Connections for I measurements with clamp

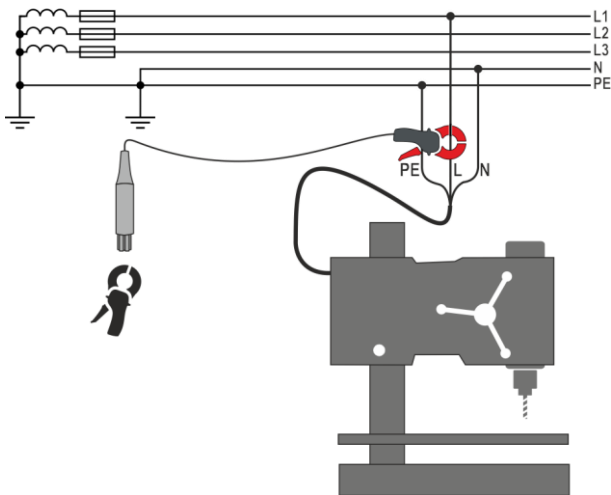

Attach clamp around measured conductor.

### 3.2.2 Connections for $I_{\Delta}$ measurements with clamp

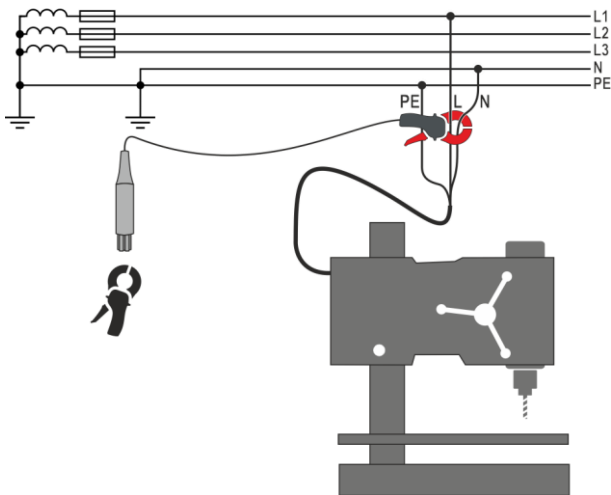

Attach clamp around L and N conductors.



### 3.2.3 Connections for I<sub>PE</sub> measurements

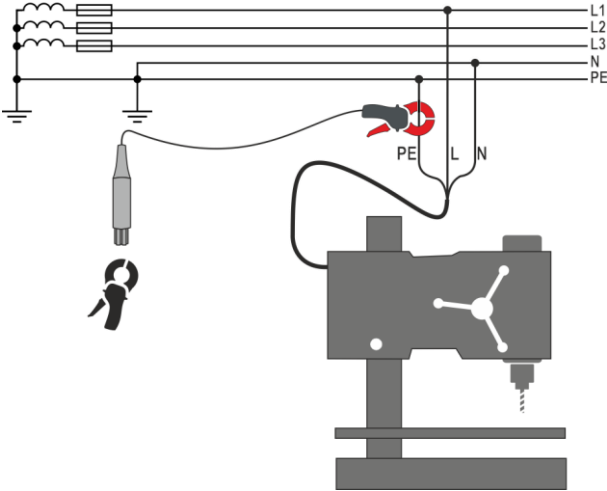

**Measurement with clamp.** Attach clamp around PE conductor.

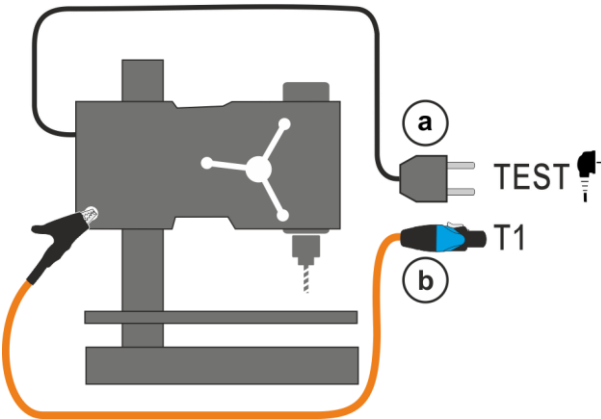

**Measurement with test socket.** Connect the mains plug of the tested appliance into the test socket of the tester (a). Additionally, it is possible to carry out the measurement with the probe connected to T1 terminal socket (b).

### 3.2.4 Connections in measurements of devices in protection class I, $I_{\Delta}$ in the socket, $I_{SUB}$ , $R_{ISO}$

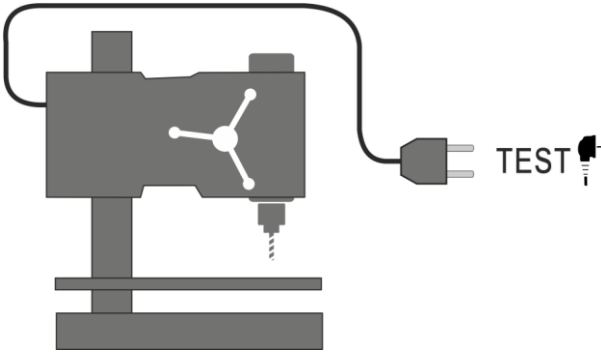

**$I_{SUB}$  measurement.** For Class I: connect the mains plug of the tested appliance into the test socket.

**$I_{\Delta}$  measurement with test socket.** Connect the mains plug of the tested appliance into the test socket.

**$I_{SUB}$  measurement with test socket.** Connect the mains plug of the tested appliance into the test socket.

**$R_{ISO}$  measurement with test socket.** Connect the mains plug of the tested appliance into the test socket of the tester. The measurement is made between L and N (which are shorted) and PE.

### 3.2.5 Connections in measurements of devices in protection class I and II, $I_{SUB}$ , $I_T$ , $R_{ISO}$

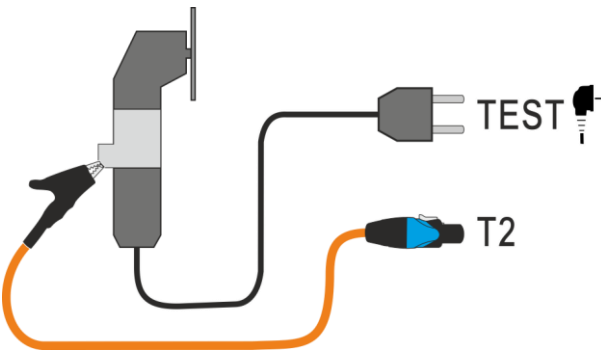

**$I_{SUB}$  measurement.** For Class II and accessible parts disconnected from PE in Class I: connect the probe to **T2** terminal socket and touch the accessible parts of the tested appliance.

**$I_T$  measurement.** Connect the mains plug of the tested appliance into the test socket of the tester. Use the probe connected to **T2** terminal socket and touch the accessible parts of the tested appliance (for Class I appliances – touch accessible parts not connected to PE).

**$R_{ISO}$  measurement.** Connect shorted L and N of the mains plug of the tested appliance to **T1** terminal socket. Using the probe connected to **T2** terminal socket touch the conductive accessible parts of the tested appliance.

### 3.2.6 Connections for $R_{ISO}$ measurements

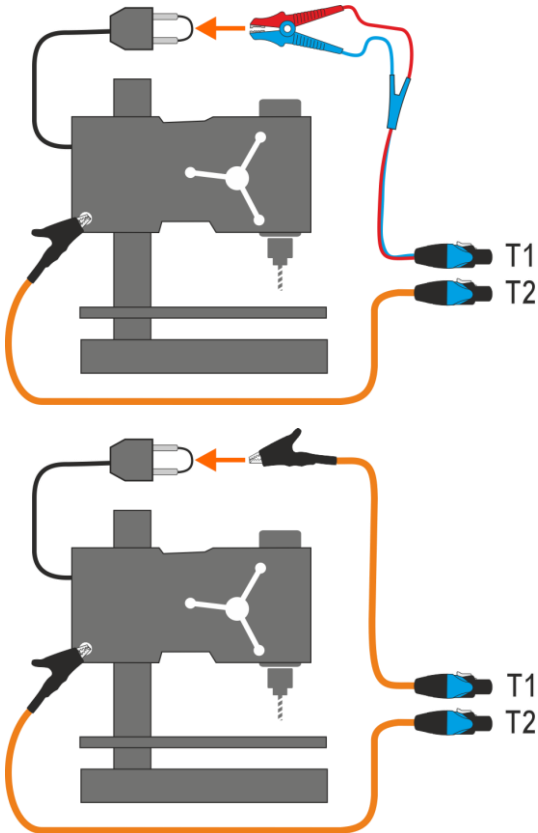

**Measurement in Class I appliances without using the test socket.** Connect shorted L and N of the mains plug of the tested appliance to **T1** terminal socket. Using the probe connected to **T2** terminal socket touch the conductive accessible parts of the tested appliance.

### 3.2.7 Connections for R<sub>PE</sub> measurements

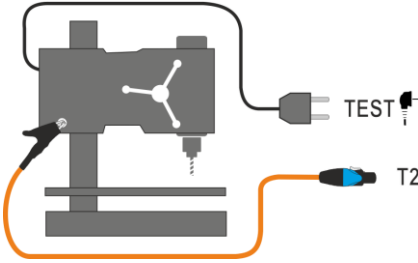

**Socket-probe measurement.**  
Connect mains plug of the appliance under test into test socket of the tester. Using the probe connected to socket **T2** touch metal parts of the tested appliance that are connected to PE.

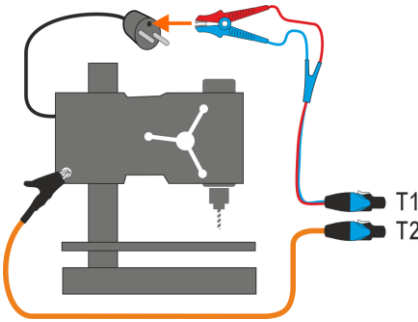

**Probe-probe measurement.**  
Connect PE of the tested appliance's mains plug into **T1** terminal socket. Using the probe connected to socket **T2** touch metal parts of the tested appliance that are connected to PE.

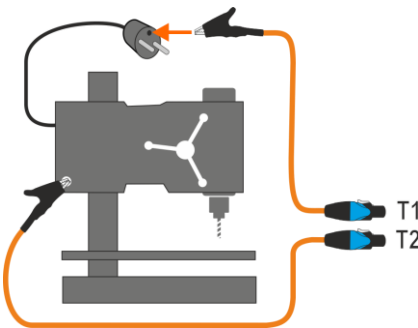

### 3.2.8 Connections in measurements of IEC devices – R<sub>ISO</sub>, R<sub>PE</sub>, IEC



### 3.2.9 Connections in measurements of PRCD devices – $I_{\Delta}$ , $I_{PE}$ , $I_T$ , $R_{PE}$

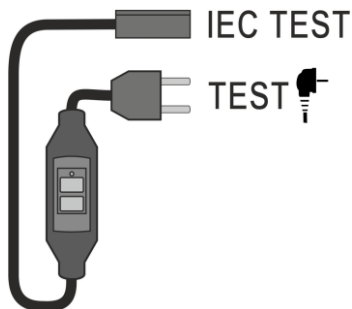

### 3.2.10 Connections in measurements of PELV devices

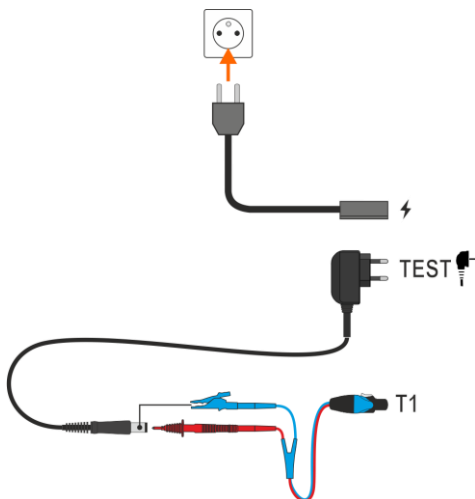

Using the 1.5 m double-wire test lead, connect the low-voltage plug of the tested voltage source to the tester's **T1** socket. Then connect the voltage source to power.

### 3.2.11 Connections in the measurement of stationary RCDs

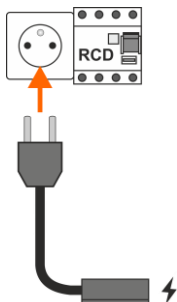

Connect the mains plug of the tester into the tested socket.

### 3.2.12 Connections in welding machine measurements

#### 3.2.12.1 Single-phase welding machine – measurement of $I_L$ , $R_{ISO}$ , $U_0$

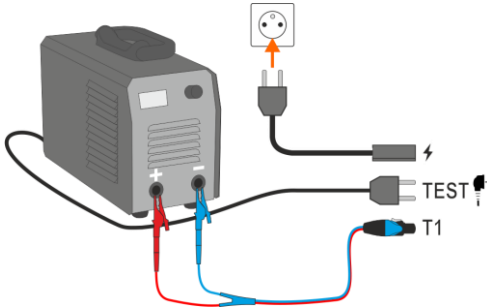

**$I_L$  measurement.** Variant with powering the welding machine from the meter's test socket (only 1-phase, max. 16 A).

**$U_0$  measurement.** Variant with powering the welding machine from the meter's test socket (only 1-phase, max. 16 A).

**$R_{ISO}$  LN-S or  $R_{ISO}$  PE-S measurement.** 1-phase appliance.

#### 3.2.12.2 Single-phase welding machine – measurement of $I_p$

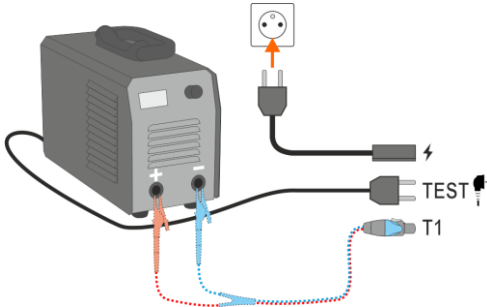

**Measurement with test socket.** Connect the mains plug of the tested appliance into the test socket of the tester. The T1 cable can be connected but does not have to be.

#### 3.2.12.3 Single-phase welding machine – measurement of $I_p$ using PAT-3F-PE adapter

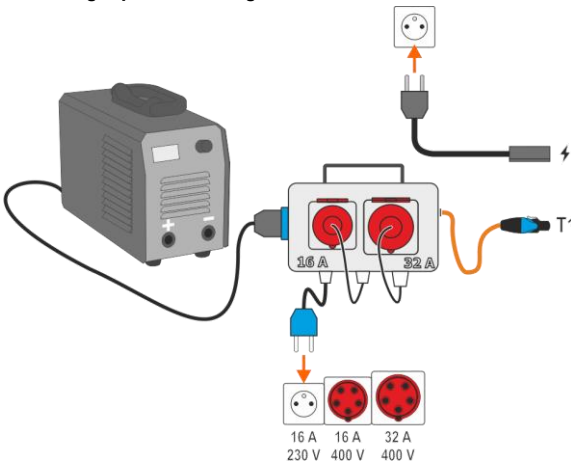

**Measurement with PAT-3F-PE adapter.** Connecting a 1-phase 230 V appliance.

### 3.2.12.4 Single-phase or three-phase welding machine – measurement of $R_{iso}$

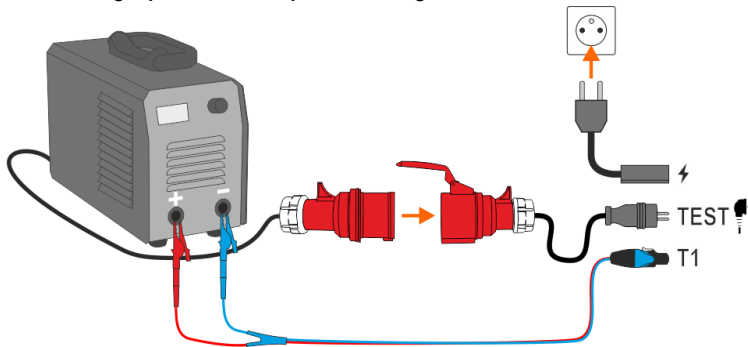

**Measurement of  $R_{iso}$  LN-S or  $R_{iso}$  PE-S.** 3-phase appliance or 1-phase appliance powered by an industrial socket.

### 3.2.12.5 Three-phase welding machine – measurement of $I_L$ , $U_0$

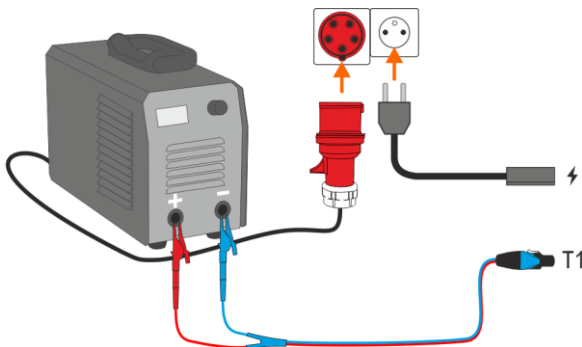

**$I_L$  measurement.** Variant with powering the welding machine directly from the mains socket.

**$U_0$  measurement.** Variant with powering the welding machine directly from the mains socket.

### 3.2.12.6 Three-phase welding machine – measurement of $I_p$ using PAT-3F-PE adapter

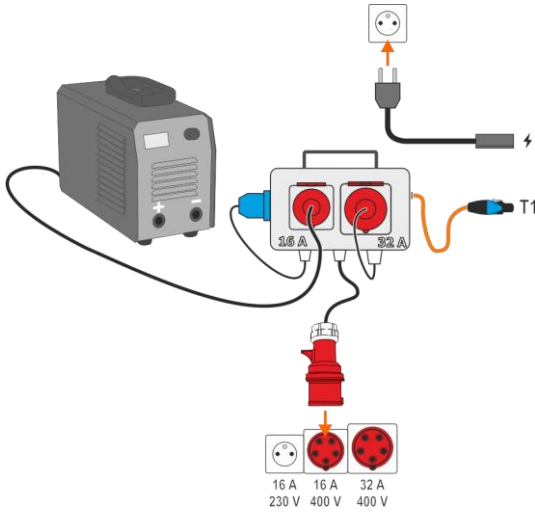

**Measurement with PAT-3F-PE adapter.** Connecting a 3-phase 16 A appliance.

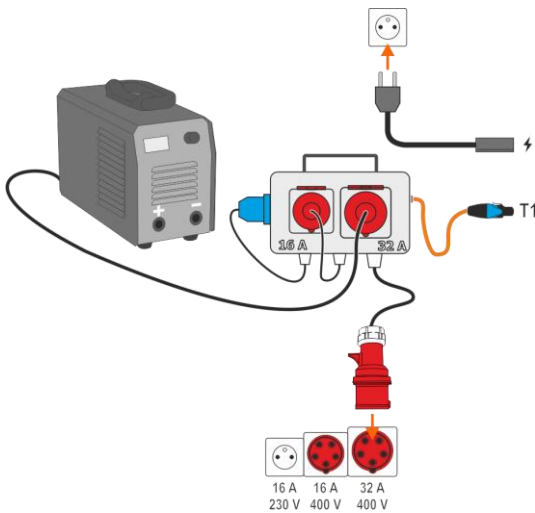

**Measurement with PAT-3F-PE adapter.** Connecting a 3-phase 32 A appliance.



### 3.2.13 Connections – power test

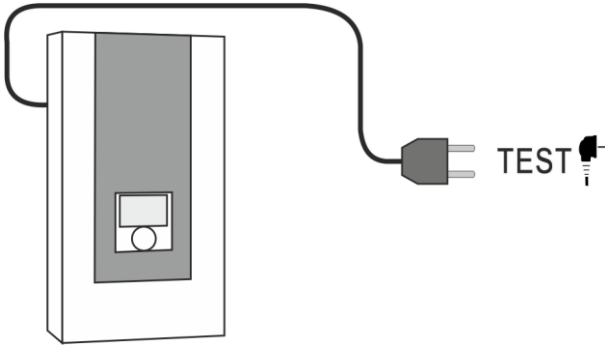

**Measurement without clamp.**  
Connect the mains plug of the tested appliance into the test socket of the tester.

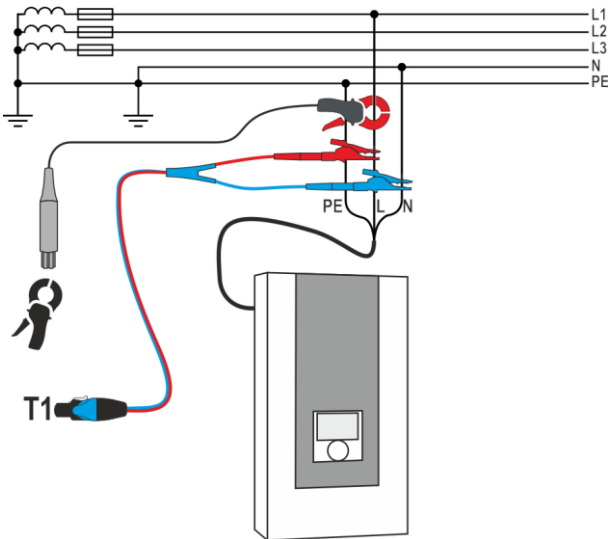

**Measurement with clamp.**  
Attach clamp around L conductor. To **T1** socket connect L and N conductors of the power cord of the tested appliance.

### 3.3 Photovoltaics

#### 3.3.1 Connections in diode tests – conduction direction (F)

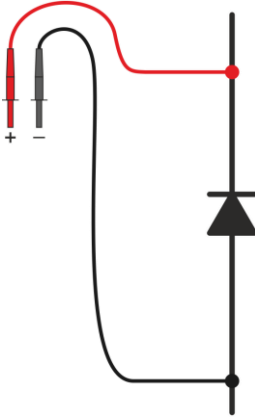

Connect test leads according to the drawing. The polarity when connecting the diode does not matter – the meter will automatically set it before taking the measurement.

#### 3.3.2 Connections in the blocking diode tests – conduction direction (F), reverse direction (R)

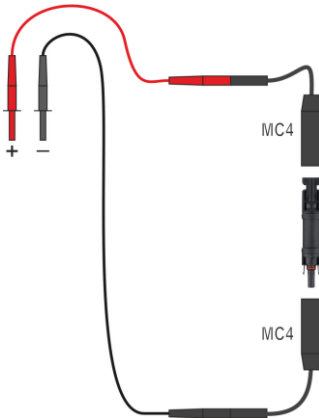

Connect test leads according to the drawing. The polarity when connecting the diode does not matter – the meter will automatically set it before taking the measurement.

### 3.3.3 Connections for I measurements

Attach clamp around measured conductor.

- a) DC side measurement.
- b) AC side measurement.

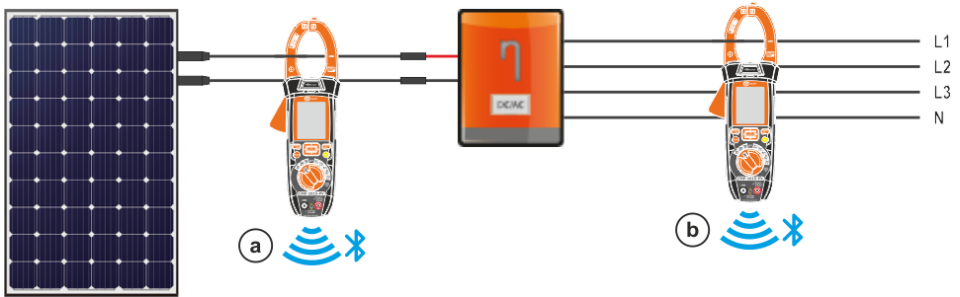

### 3.3.4 Connections for $I_{sc}$ , $U_{oc}$ , I-U measurements

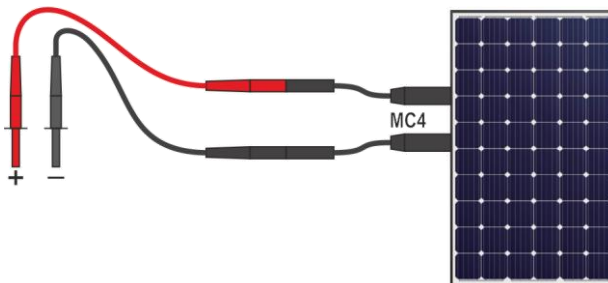

### 3.3.5 Connections for P measurements

Attach clamp around measured conductor.

- a DC side measurement.
- b AC side measurement.

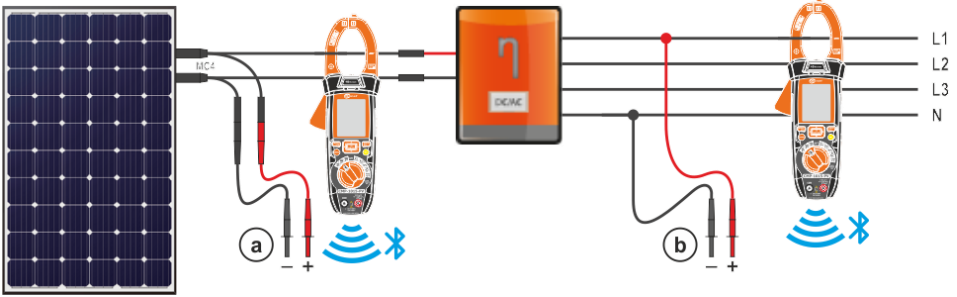

### 3.3.6 Connections for $R_{ISO}$ measurements



During the measurement, **make sure that test leads and crocodile clips do not touch each other and/or ground**, because such a contact may cause the flow of surface currents resulting in additional error in measurement results.

The standard way of measuring the insulation resistance ( $R_{ISO}$ ) is the two-lead method See also **sec. 3.1.2**.

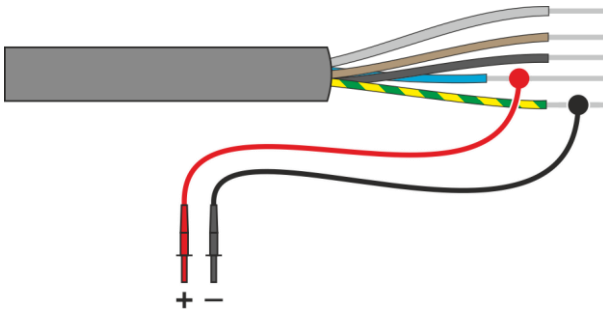

### 3.3.7 Connections for $R_{iso}$ PV measurements

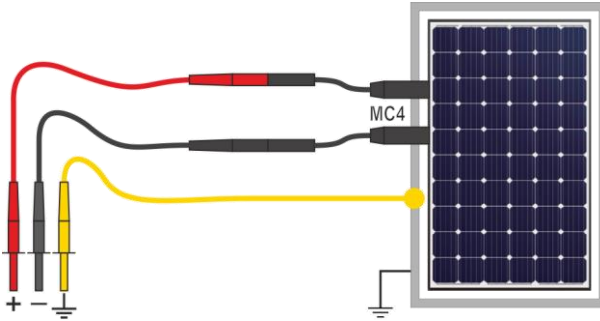

The PV system has an accessible, grounded structure (including frames of the module). Then one measurement is enough.

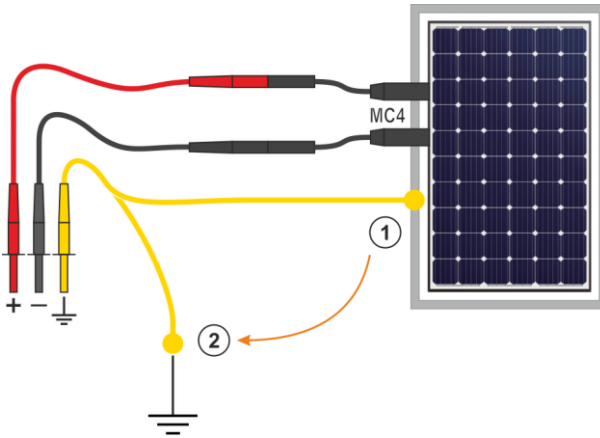

The PV system has no grounded structure. Then, two measurements are necessary:

- 1 between system wires "+", "-" and the system frame,
- 2 between system wires "+", "-" and the grounding.

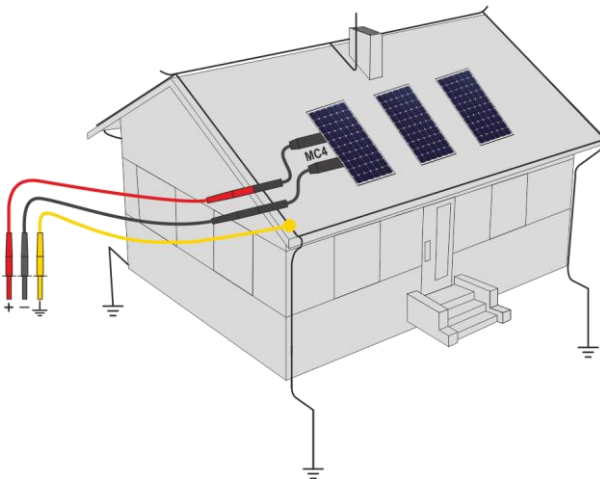

The PV system has no conductive parts available (e.g. solar roof tiles). Then, the measurement should be made between system wires "+", "-" and grounding of the building.

## 4 Measurements. Visual test

1



Select **Visual test**.

2

From the list of options that can be used, select the result of your inspection. Touch each item as many times as is needed to enter the appropriate test result:



– not performed,



– passed,



– failed,



– undefined (no clear assessment),



– not applicable (not applicable to a given aspect),



– omitted (intentional, deliberate omission, e.g. due to no access).



If any option you need is missing, you can add it to the list.



3



End the test.

4

The test summary screen will appear. Touching the bar with the result will reveal your selections from **step 2**. If you want to enter additional information about the study, expand the **Attachments** field and fill in the comment field.

# 5 Measurements. Electrical safety

## 5.1 DD – Dielectric Discharge Indicator

The purpose of the test is to check the degree of moisture in the insulation of the tested object. The greater its moisture content, the greater the dielectric discharge current.

In the dielectric discharge test, after 60 seconds from the end of measurement (charging) of the insulation, the discharge current is measured. The DD is a value characterising the insulation quality independent from the test voltage.

The measurement operates in the following way:

- First the insulation is charged with a current for a set period. If the voltage is not equal to the set voltage, the object is not charged and the meter abandons the measurement procedure after 20 seconds.
- After the charging and polarisation is complete, the only current flowing through the insulation is the leakage current.
- Then the insulation is discharged and the total dielectric discharge current starts to flow through the insulation. Initially this current is the sum of the capacitance discharge current, which fades quickly with the absorption current. The leakage current is negligible, because there is no test voltage.
- After 1 minute from closing the circuit the current is measured.

The DD value is calculated using the formula:

$$DD = \frac{I_{1\min}}{U_{pr} \cdot C}$$





where:

$I_{1\min}$  – current measured 1 minute after closing the circuit [nA],

$U_{pr}$  – test voltage [V],

$C$  – capacitance [ $\mu$ F].

The measurement result indicates the status of the insulation. It may be compared with the following table.

DD value	Insulation condition	
>7	Bad	
4-7	Weak	
2-4	Acceptable	
<2	Good	

To take a measurement, you must set ():

- nominal test voltage  $U_n$ ,
- total duration of the measurement  $t$ ,
- limits (if necessary).

The meter will suggest possible settings.

1



- Select **DD** measurement.
- Enter the measurement settings (**sec. 2.3**).

2

Connect test leads according to **sec. 3.1.2**.

3

5 s



Press and hold **START** button for **5 seconds**. This will trigger a 5-second countdown, after which the measurement will **start**.



Quick start (without a delay of 5 seconds) perform by sliding the **START** button.

Testing will continue **until it reaches the preset time** or until is pressed.



Touching the bar with the result reveals partial results.



During the measurement, it is possible to display the graph (**sec. 9.1**).

4

After the measurement is completed, you can read the result. Touching the bar with the result will now also reveal partial results.

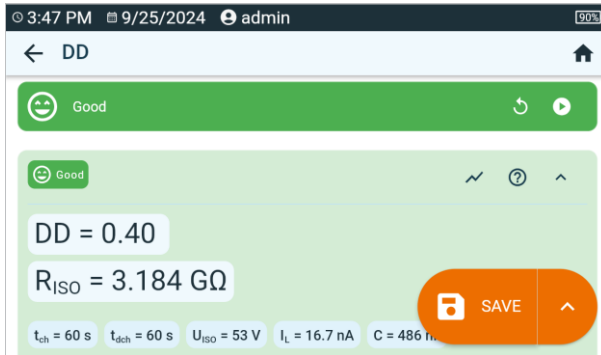

You can now also display the graph (**sec. 9.1**).

5

You may do the following with the measurement result:



ignore and exit to the measurement menu,



repeat it (the selection window for the measurement you want to repeat will be shown),



**SAVE** – save to memory,



▶ **SAVE AND ADD** – create a new folder/device which is equivalent to the folder/device where the result of the previously performed measurement was saved,



▶ **SAVE TO THE PREVIOUS ONE** – save the result in the folder/device where the result of the previously performed measurement was saved.



In environments with strong electromagnetic interferences the measurement may be affected by an additional error.



## 5.2 EPA – measurements in the EPAs

In EPAs (Electrostatic Protected Areas) materials for protection against electrostatic discharge (ESD) are used. They are classified according to their resistance and resistivity characteristics.

**ESD shielding materials** – full protection of this type is provided by a Faraday cage. An important material shielding from static discharges is conductive metal or carbon, which suppresses and weakens the energy of the electric field.

**Conductive materials** – have low resistance, enabling the charges to move quickly. If the conductive material is grounded, charges flow away quickly. Examples of conductive materials: carbon, metals-conductors.

**Charge-dissipating materials** – in these materials, charges flow to the ground more slowly than in the case of conductive materials, their destructive potential is reduced.

**Insulating materials** – difficult to ground. Static charges remain in this type of material for a long time. Examples of insulating materials: glass, air, commonly used plastic packaging.

Material	Criteria
ESD discharge shielding materials	$R_{VOL} > 100 \Omega$
Conductive materials	$100 \Omega \leq R_{SUR} < 100 \text{ k}\Omega$
Charge dissipating materials	$100 \text{ k}\Omega \leq R_{VOL} < 100 \text{ G}\Omega$
Insulating materials	$R_{SUR} \geq 100 \text{ G}\Omega$

To take a measurement, you must set (EN 61340-4-1):

- test voltage  $U_n$  – according to EN 61340-4-1: 10 V / 100 V / 500 V,
- measurement duration  $t$  – according to EN 61340-4-1: 15 s  $\pm$  2 s,
- measurement method:
  - ⇒ point-to-point resistance –  $R_{P1-P2}$ ,
  - ⇒ point-to-ground resistance –  $R_{P-G}$ ,
  - ⇒ surface resistance –  $R_{SUR}$ ,
  - ⇒ volume resistance –  $R_{VOL}$ .
- limits – see evaluation criteria according to EN 61340-5-1 (table below).

Material	Criteria
Surfaces	$R_{P-G} < 1 \text{ G}\Omega$ $R_{P1-P2} < 1 \text{ G}\Omega$
Floors	$R_{P-G} < 1 \text{ G}\Omega$
Conductive packaging	$100 \Omega \leq R_{SUR} < 100 \text{ k}\Omega$
Load-dissipating packaging	$100 \text{ k}\Omega \leq R_{SUR} < 100 \text{ G}\Omega$
Insulating packaging	$R_{SUR} \geq 100 \text{ G}\Omega$

Detailed guidelines can be found in the standards: IEC 61340-5-1, IEC/TR 61340-5-2, ANSI/ESD S20.20, ANSI/ESD S541 and in the standards referred to in the above-mentioned documents.

1



- Select **EPA** measurement.
- Select the measurement method (**sec. 2.3**).
- Enter the measurement settings (**sec. 2.3**).

2

Connect the measurement system according to the adopted measurement method (**sec. 3.1.1**).

3



Press and hold **START** button for **5 seconds**. This will trigger a 5-second countdown, after which the measurement will **start**.



Quick start (without a delay of 5 seconds) perform by sliding the **START** button.

Testing will continue **until it reaches the preset time** or until  is pressed.



Touching the bar with the result reveals partial results.

4

After the measurement is completed, you can read the result. Touching the bar with the result will now also reveal partial results.

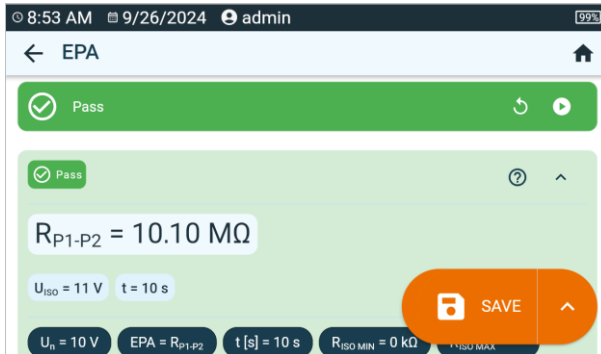

5

You may do the following with the measurement result:



ignore and exit to the measurement menu,

repeat it (the selection window for the measurement you want to repeat will be shown),



**SAVE** – save to memory,



**SAVE AND ADD** – create a new folder/device which is equivalent to the folder/device where the result of the previously performed measurement was saved,



**SAVE TO THE PREVIOUS ONE** – save the result in the folder/device where the result of the previously performed measurement was saved.

## 5.3 RampTest – measurement with ramp test

Measurement with increasing voltage (RampTest) is to determine at which DC voltage value the insulation will (or will not) break down. The essence of this function is:

- to test the measured object with the voltage increasing to the final value  $U_n$ ,
- to check if the object will retain electrical insulating properties when the maximum voltage  $U_n$  is present there for the preset time  $t_2$ .

The measuring procedure is illustrated in the graph below.

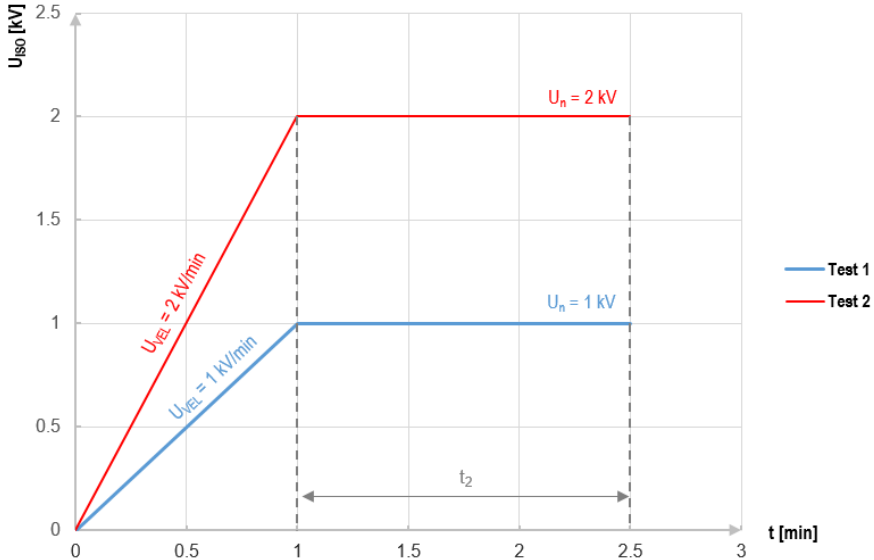

Graph 5.1. Voltage supplied by the meter as a function of time for two exemplary increase rates

To perform the measurement, first set (  ):

- voltage  $U_n$  – voltage at which the rise is to end. It can be within the range of  $50\text{ V} \dots U_{MAX}$ ,
- time  $t$  – total duration of the measurement,
- time  $t_2$  – time during which the voltage should be maintained on the tested object (**Graph 5.1**),
- maximum short-circuit current  $I_{SC}$  – if during the measurement the meter **reaches the preset value** it will enter the mode of current limit, which means that it **will stop further increase** of forced current on this value,
- leakage current limit  $I_L$  ( $I_L \leq I_{SC}$ ) – if the measured leakage current **reaches the preset value** (a breakdown of the tested object occurs), the measurement is **stopped** and the meter displays the voltage at which it occurred.

1



- Select **RampTest** measurement.
- Enter the measurement settings (**sec. 2.3**).

2

Connect test leads according to **sec. 3.1.2**.

3



Press and hold **START** button for **5 seconds**. This will trigger a 5-second count-down, after which the measurement will **start**.



Quick start (without a delay of 5 seconds) perform by sliding the **START** button.

Testing will continue **until it reaches the preset time** or until  is pressed.



Touching the bar with the result reveals partial results.



During the measurement, it is possible to display the graph (**sec. 9.1**).

4

After the measurement is completed, you can read the result. Touching the bar with the result will now also reveal partial results.

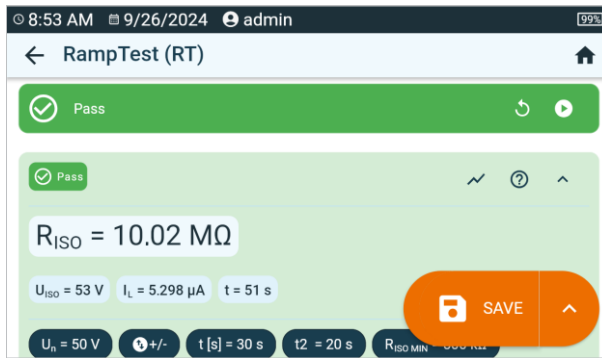

You can now also display the graph (**sec 9.1**).

5

You may do the following with the measurement result:



ignore and exit to the measurement menu,

repeat it (the selection window for the measurement you want to repeat will be shown),



**SAVE** – save to memory,



▶ **SAVE AND ADD** – create a new folder/device which is equivalent to the folder/device where the result of the previously performed measurement was saved,



▶ **SAVE TO THE PREVIOUS ONE** – save the result in the folder/device where the result of the previously performed measurement was saved.

## 5.4 R<sub>ISO</sub> – insulation resistance

The instrument measures the insulation resistance by applying the measuring voltage  $U_n$  to the tested resistance  $R$  and measuring the current  $I$  flowing through it. When calculating the value of the insulation resistance, the meter uses the technical method of resistance measurement ( $R = U/I$ ).

To take a measurement, you must set (☰):

- nominal test voltage  $U_n$ ,
- duration of the measurement  $t$  (if allowed by the hardware platform),
- times  $t_1$ ,  $t_2$ ,  $t_3$  needed for calculating absorption coefficients (if allowed by the hardware platform),
- limits (if necessary).

The meter will suggest possible settings.



### WARNING

The tested object must not be live.

### 5.4.1 Measurements with the use of test leads

1



- Select  $R_{ISO}$  measurement.
- Enter the measurement settings (sec. 2.3).

2

Connect test leads according to **sec. 3.1.2**.

3



Press and hold the **START** button for **5 seconds**. This will trigger a countdown, during which the meter does not generate a dangerous voltage, and the measurement can be interrupted without the need to discharge the tested object. After the countdown, the measurement will **start**.



Quick start (without a delay of 5 seconds) perform by sliding the **START** button.

Testing will continue **until it reaches the preset time** or until  is pressed.



Touching the bar with the result reveals partial results.



During the measurement, it is possible to display the graph (**sec. 9.1**).



## 5.4.2 Measurements using the AutoISO-2511 adapter

1



Select  $R_{ISO}$  measurement.

2

Connect the adapter according to **sec. 3.1.3**.



After connecting the adapter, the list of available measurement functions will be narrowed down to those dedicated to the adapter.

3

The screen displays the icon for selecting the number of wires of the tested object.



- Determine the number of wires of the tested object.
- For each pair of conductors enter the measurement settings (**sec. 2.3**).

4

Connect the adapter to the tested object.

5



Press and hold the **START** button for **5 seconds**. This will trigger a countdown, after which the measurement will **start**.



Quick start (without a delay of 5 seconds) perform by sliding the **START** button.

Testing will continue **until it reaches the preset time** or until  is pressed.



Touching the bar with the result reveals partial results.



During the measurement, it is possible to display the graph (**sec. 9.1**).

6

After the measurement is completed, you can read the result. Touching the bar with the result will now also reveal partial results.

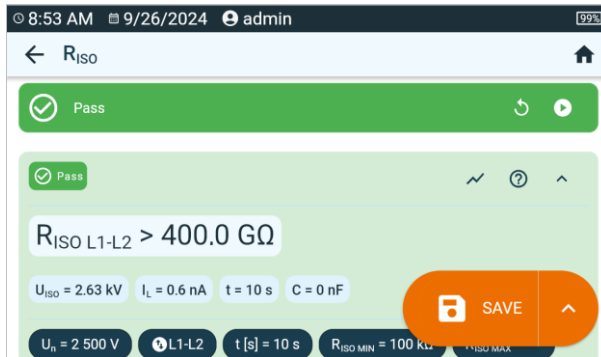

$U_{ISO}$  – test voltage  
 $I_L$  – leakage current



You can now also display the graph (**sec. 9.1**).

7

You may do the following with the measurement result:



ignore and exit to the measurement menu,

repeat it (the selection window for the measurement you want to repeat will be shown),



**SAVE** – save to memory,



▶ **SAVE AND ADD** – create a new folder/device which is equivalent to the folder/device where the result of the previously performed measurement was saved,



▶ **SAVE TO THE PREVIOUS ONE** – save the result in the folder/device where the result of the previously performed measurement was saved.



- Disabling  $t_2$  time will also disable  $t_3$ .
- The timer measuring the measurement time is started when  $U_{ISO}$  voltage is stabilized.
- **LIMIT I** informs of an operation with limited inverter power. If this condition persists for 20 seconds, the measurement is stopped.
- If the meter is unable to charge the capacitance of the tested object, **LIMIT I** is displayed and after 20 s **the measurement is stopped**.
- A short tone informs for every period of 5 seconds of time that has lapsed. When the timer reaches characteristic points ( $t_1$ ,  $t_2$ ,  $t_3$  times), then for 1 second, an icon of this point is displayed which is accompanied by a long beep.
- If the value of any of the measured partial resistance is out of range, then the value of the absorption coefficient is not shown and horizontal dashes are displayed.
- After completion of the measurement, the capacitance of the tested object is discharged by shorting  $R_{ISO+}$  and  $R_{ISO-}$  terminals with resistance of ca. 100 kΩ. At the same time, the message **DISCHARGING** is displayed, as well as the value of  $U_{ISO}$  voltage that is present at that time on the object.  $U_{ISO}$  decreases over time until it is fully discharged.



## 5.5 R<sub>ISO</sub> 60 s – Dielectric Absorption Ratio (DAR)

The dielectric absorption ratio (DAR) determines the state of insulation through the ratio of the measured resistance value at the two moments of measurement ( $R_{t1}$ ,  $R_{t2}$ ).

- Time  $t_1$  is the 15th or 30th second of measurement.
- Time  $t_2$  is the 60. second of measurement.

The DAR value is calculated using the formula:





$$DAR = \frac{R_{t2}}{R_{t1}}$$

where:

$R_{t2}$  – resistance measured at time  $t_2$ ,

$R_{t1}$  – resistance measured at time  $t_1$ .

The measurement result indicates the status of the insulation. It may be compared with the following table.

DAR value	Insulation condition	
<1	Bad	
1-1,39	Undetermined	
1,4-1,59	Acceptable	
>1,6	Good	

To take a measurement, you must set ( $\Xi$ ):

- Test voltage  $U_n$ ,
- time  $t_1$ .

1



- Select **DAR (R<sub>ISO</sub> 60 s)** measurement.
- Enter the measurement settings (**sec. 2.3**).

2

Connect test leads according to **sec. 3.1.2**.

3



Press and hold the **START** button for **5 seconds**. This will trigger a countdown, during which the meter does not generate a dangerous voltage, and the measurement can be interrupted without the need to discharge the tested object. After the countdown, the measurement will **start**.



Quick start (without a delay of 5 seconds) perform by sliding the **START** button.

Testing will continue **until it reaches the preset time** or until  is pressed.



Touching the bar with the result reveals partial results.

4

After the measurement is completed, you can read the result. Touching the bar with the result will now also reveal partial results.

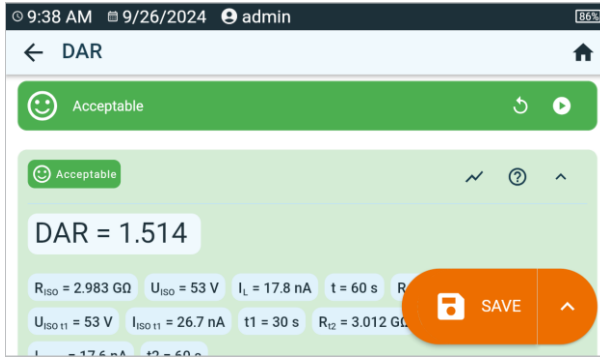

5

You may do the following with the measurement result:



ignore and exit to the measurement menu,

repeat it (the selection window for the measurement you want to repeat will be shown),



**SAVE** – save to memory,



▶ **SAVE AND ADD** – create a new folder/device which is equivalent to the folder/device where the result of the previously performed measurement was saved,



▶ **SAVE TO THE PREVIOUS ONE** – save the result in the folder/device where the result of the previously performed measurement was saved.



4

After the measurement is completed, you can read the result. Touching the bar with the result will now also reveal partial results.

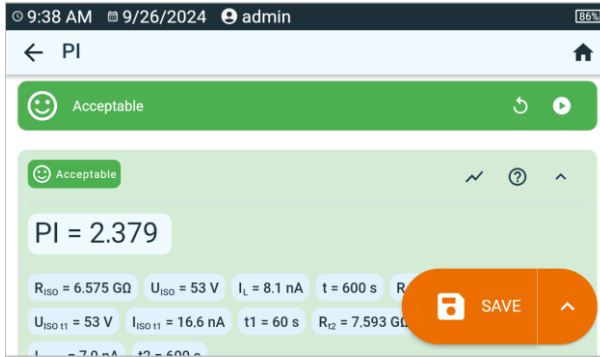

5

You may do the following with the measurement result:



ignore and exit to the measurement menu,



repeat it (the selection window for the measurement you want to repeat will be shown),



**SAVE** – save to memory,



▶ **SAVE AND ADD** – create a new folder/device which is equivalent to the folder/device where the result of the previously performed measurement was saved,



▶ **SAVE TO THE PREVIOUS ONE** – save the result in the folder/device where the result of the previously performed measurement was saved.



The polarization index value obtained during a measurement in which  $R_{t1} > 5 \text{ G}\Omega$  should not be taken as a reliable assessment of insulation condition.

## 5.7 $R_X$ , $R_{CONT}$ – low-voltage measurement of resistance

### 5.7.1 Autozero – calibration of test leads

In order to eliminate the impact of the resistance of test leads on measurement result, the compensation (nulling) of their resistance may be performed.

1



Select **Autozero**.

2a



Short the test leads used for measuring  $R_X$  or  $R_{CONT}$ . The meter will measure the resistance of test leads three times. It will then provide the **result decreased** by this resistance, while the resistance measurement window will show the message **Autozero (On)**.

3b



To **disable compensation** of the resistance of leads, repeat **step 2a** with **open test leads** and press . Then the measurement result will **contain the resistance of test leads**, while the resistance measurement window will show the message **Autozero (Off)**.

### 5.7.2 $R_X$ – measurement of resistance

1



Select  $R_X$  measurement.

2

Connect test leads according to **sec. 3.1.4**.

3



Measurement starts automatically and lasts continuously.



### 5.7.3 $R_{CONT}$ – measurement of resistance of protective conductors and equipotential bonding with $\pm 200$ mA current

1



- Select  $R_{CONT}$  measurement.
- Enter the measurement settings (sec. 2.3).

2

Connect test leads according to sec. 3.1.4.

3



Press **START**.

Testing will continue **until it reaches the preset time** or until  is pressed.



Touching the bar with the result reveals partial results.

4

After the measurement is completed, you can read the result. Touching the bar with the result will now also reveal partial results.

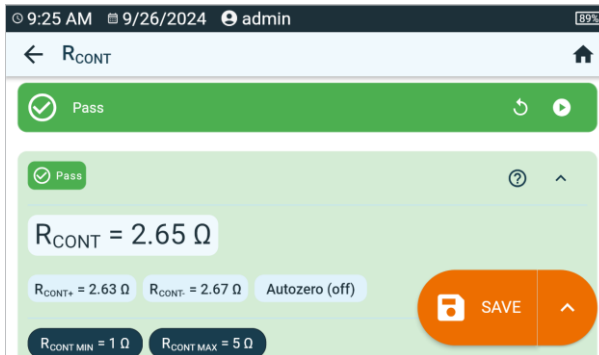

The result is the arithmetic mean of the values of two measurements at a current of 200 mA with opposite polarities:  $R_{CONT+}$  and  $R_{CONT-}$ .

$$R = \frac{R_{CONT+} + R_{CONT-}}{2}$$

# 5

You may do the following with the measurement result:



ignore and exit to the measurement menu,  
repeat it (the selection window for the measurement you want to repeat will be shown),



**SAVE** – save to memory,



**SAVE AND ADD** – create a new folder/device which is equivalent to the folder/device where the result of the previously performed measurement was saved,



**SAVE TO THE PREVIOUS ONE** – save the result in the folder/device where the result of the previously performed measurement was saved.

## 5.8 SPD – testing surge protecting devices

SPDs (*surge protecting devices*) are used in facilities with and without lightning protection installations. They ensure the safety of the electrical installation in the event of an uncontrolled voltage surge in the network, e.g. due to lightning. SPDs for protecting electrical installations and devices connected to them are most often based on varistors or spark gaps.

Varistor type surge protecting devices are subject to aging processes: the leakage current, which for new devices is 1 mA (as defined in the EN 61643-11 standard), increases over time, causing the varistor to overheat, which in turn may lead to a short circuit of its structure. The environmental conditions in which the surge protecting devices was installed (temperature, humidity, etc.) and the number of overvoltages correctly conducted to earth are also important for the life of surge protecting device.

The surge protecting device is subject to breakdown (discharges the surge impulse to ground) when the surge exceeds its highest permanent operating voltage  $U_C$ . The test allows user to determine whether this is done correctly. The meter applies increasingly higher voltage to the surge protecting device with a specific voltage increase ratio, checking the value for which a leakage current of 1 mA will occur.

A distinction is made between arresters for AC voltage and DC voltage. The measurement is made with DC voltage, so if the tested arrester operates on AC voltage, the result is converted from DC voltage to AC voltage according to the following formula:

$$U_C = \frac{U_{DC}}{1.15\sqrt{2}}$$

A surge protector can be considered faulty when the **highest permanent operating voltage  $U_C$** :

- **is too high** (e.g., 30% higher than declared by the manufacturer) – then the installation protected by the arrester is not fully protected, as smaller overvoltage surges may penetrate it,
- **is too low** – this means that the arrester may discharge to the ground signals close to the rated voltage to ground.

Before the test:

- check the safe voltages for the tested limiter. Make sure you don't damage it with the test parameters you set. In case of difficulties, follow the EN 61643-11 standard or the guidelines of the surge protector manufacturer,
- disconnect the limiter from the voltage – disconnect the voltage wires from it or remove the insert that will be tested.

To take a measurement, you must set ( $\text{⚙}$ ):

- **voltage type** at which the arrester operates (AC or DC),
- **$R_{ISO} U_n$**  measurement voltage – maximum voltage that can be applied to the limiter. The voltage increase ratio also depends on its selection (1000 V: 200 V/s, 2500 V: 500 V/s),
- **$U_{C MAX}$**  voltage limit – parameter given on the housing of the tested limiter. This is the maximum voltage at which breakdown should not occur,
- **$U_{C TOL}$  [%]** tolerance range for the actual breakdown voltage. It defines the range of  $U_{C MIN} \dots U_{C MAX}$ , in which the actual operating voltage of the limiter should be included, where:

$$U_{C MIN} = (100\% - U_{C TOL}) U_{C MAX}$$
$$U_{C MAX} = (100\% + U_{C TOL}) U_{C MAX}$$

The tolerance value should be obtained from materials provided by the limiter manufacturer, e.g. from the catalogue card. The EN 61643-11 standard allows a maximum of 20% tolerance.



1



- Select **SPD** measurement.
- Enter the measurement settings (**sec. 2.3**).

2

Connect test leads:

- + to the surge protector's phase terminal,
- - to the surge protector's earthing terminal.

3



Press and hold **START** button for **5 seconds**. This will trigger a 5-second count-down, after which the measurement will **start**.



Quick start (without a delay of 5 seconds) perform by sliding the **START** button.

The test will continue **until the breakdown of the protector occurs** or until  is pressed.

4

After the measurement is completed, you can read the result. Touching the bar with the result will now also reveal partial results.



#### For arresters for AC voltage

$U_C$  – arrester breakdown voltage (AC)

$U_{Cdc} = U_{Dc}$  – DC voltage at which the protector breakdown occurred

#### For arresters for DC voltage

$U_C = U_{Dc}$  – DC voltage at which the protector breakdown occurred

#### Other parameters

**SPD:...** – protector type identified

$R_{iso} U_n$  – maximum DC measuring voltage

$U_C \text{ MIN}$  – lower limit of the range in which the  $U_C$  voltage should be included

$U_C \text{ MAX}$  – upper limit of the range in which the  $U_C$  voltage should be included

$U_C \text{ MAX}$  – maximum operating voltage value given on the protector

$U_C \text{ TOL}$  – tolerance range for the actual breakdown voltage of the protector

# 5

You may do the following with the measurement result:



ignore and exit to the measurement menu,  
repeat it (the selection window for the measurement you want to repeat will be shown),



**SAVE** – save to memory,



**SAVE AND ADD** – create a new folder/device which is equivalent to the folder/device where the result of the previously performed measurement was saved,



**SAVE TO THE PREVIOUS ONE** – save the result in the folder/device where the result of the previously performed measurement was saved.

## 5.9 SV – measurements with a voltage increasing in steps

Measurement with step voltage (SV) indicates that regardless of the value of the test voltage, an object with good resistance properties should not significantly change its resistance. In this mode the meter performs a series of 5 measurements with step voltage; the voltage change depends on the set maximum voltage:

- **250 V:** 50 V, 100 V, 150 V, 200 V, 250 V,
- **500 V:** 100 V, 200 V, 300 V, 400 V, 500 V,
- **1 kV:** 200 V, 400 V, 600 V, 800 V, 1000 V,
- **2.5 kV:** 500 V, 1 kV, 1.5 kV, 2 kV, 2.5 kV,
- **Custom:** you can enter any maximum voltage  $U_{MAX}$ , which will be reached in steps of  $\frac{1}{5} U_{MAX}$ . For example **700 V:** 140 V, 280 V, 420 V, 560 V, 700 V.



Available voltages depend on the hardware platform.

To perform a measurement, first set (⚙️):

- maximum (final) measurement voltage  $U_n$ ,
- total duration of the measurement  $t$ .

The result for each of the five measurements is saved, which is signalled by a beep.

1



- Select **SV** measurement.
- Enter the measurement settings (**sec. 2.3**).

2

Connect test leads according to **sec. 3.1.2**.

3



Press and hold **START** button for **5 seconds**. This will trigger a 5-second count-down, after which the measurement will **start**.



Quick start (without a delay of 5 seconds) perform by sliding the **START** button.

Testing will continue **until it reaches the preset time** or until  is pressed.



Touching the bar with the result reveals partial results.



During the measurement, it is possible to display the graph (**sec. 9.1**).

4

After the measurement is completed, you can read the result. Touching the bar with the result will now also reveal partial results.

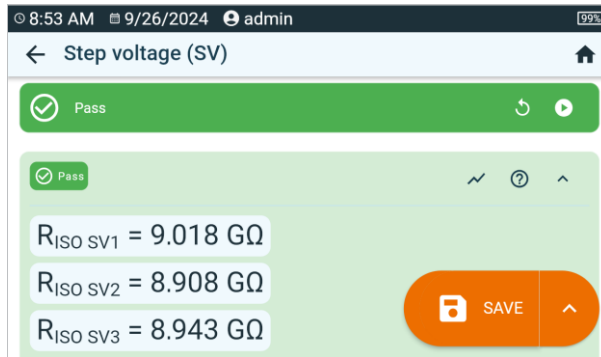

You can now also display the graph (sec. 9.1).

5

You may do the following with the measurement result:



ignore and exit to the measurement menu,



repeat it (the selection window for the measurement you want to repeat will be shown),



**SAVE** – save to memory,



▶ **SAVE AND ADD** – create a new folder/device which is equivalent to the folder/device where the result of the previously performed measurement was saved,



▶ **SAVE TO THE PREVIOUS ONE** – save the result in the folder/device where the result of the previously performed measurement was saved.



- Disabling  $t_2$  time will also disable  $t_3$ .
- The timer measuring the measurement time is started when  $U_{ISO}$  voltage is stabilized.
- **LIMIT I** informs of an operation with limited inverter power. If this condition persists for 20 seconds, the measurement is stopped.
- If the meter is unable to charge the capacitance of the tested object, **LIMIT I** is displayed and after 20 s **the measurement is stopped**.
- A short tone informs for every period of 5 seconds of time that has lapsed. When the timer reaches characteristic points ( $t_1$ ,  $t_2$ ,  $t_3$  times), then for 1 second, an icon of this point is displayed which is accompanied by a long beep.
- If the value of any of the measured partial resistance is out of range, then the value of the absorption coefficient is not shown and horizontal dashes are displayed.
- After completion of the measurement, the capacitance of the tested object is discharged by shorting  $R_{ISO+}$  and  $R_{ISO-}$  terminals with resistance of ca. 100 kΩ. At the same time, the message **DISCHARGING** is displayed, as well as the value of  $U_{ISO}$  voltage that is present at that time on the object.  $U_{ISO}$  decreases over time until it is fully discharged.

## 5.10 U – voltage

With this function you will measure the voltage on the tested object.

To take a measurement, you must set () the wire markings between which you are testing the voltage.

1



Select **U** measurement.

2

Connect the measuring system according to **sec. 3.1.5**.

3

The current readings will appear on the screen.

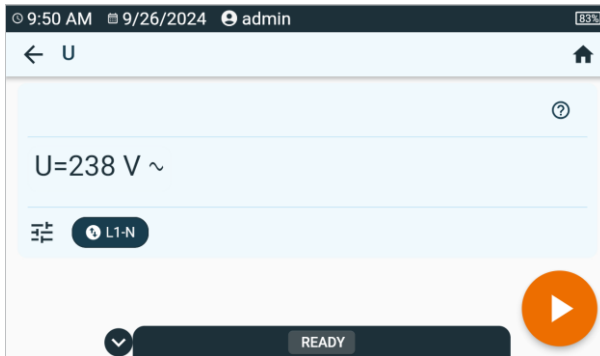

4



Press **START** button to enable the result to be written to memory.

5

You may do the following with the measurement result:



ignore and exit to the measurement menu,

repeat it (the selection window for the measurement you want to repeat will be shown),



**SAVE** – save to memory,



▶ **SAVE AND ADD** – create a new folder/device which is equivalent to the folder/device where the result of the previously performed measurement was saved,



▶ **SAVE TO THE PREVIOUS ONE** save the result in the folder/device where the result of the previously performed measurement was saved.

# 6 Measurements. Safety of electrical equipment

## 6.1 $I_{\text{Clamp}}$ – measurement of current with clamp

The purpose of the test is to measure the current that the tested device draws from the mains.

To take a measurement, you must set ( $\overline{\text{I}}_{\text{Clamp}}$ ):

- test duration  $t$ ,
- whether the measurement is continuous or not ( $\infty$  = **yes** – the test is continued until the **STOP** button is pressed,  $\infty$  = **no** – time  $t$  is respected),
- limit (if necessary).



### WARNING

During the measurement, the same mains voltage is present at the measuring socket which powers the tested appliance.

1



- Select  $I_{\text{Clamp}}$  measurement.
- Enter the measurement settings (**sec. 2.3**).

2

Connect the clamp according to **sec. 3.2.1**.

3



Press **START** button.

Testing will continue **until it reaches the preset time** or until  is pressed.



Touching the bar with the result reveals partial results.

4

After the measurement is completed, you can read the result. Touching the bar with the result will now also reveal partial results.

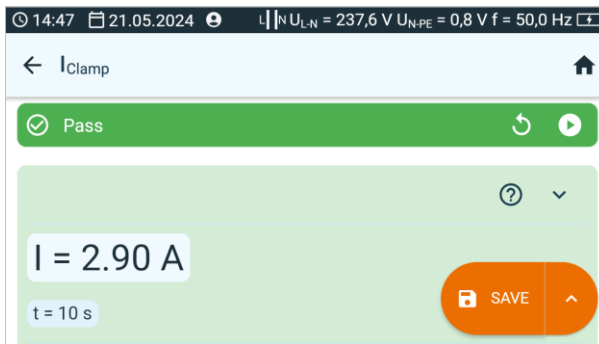

$t$  – test duration

# 5

You may do the following with the measurement result:



ignore and exit to the measurement menu,  
repeat it (the selection window for the measurement you want to repeat will be shown),



**SAVE** – save to memory,



**SAVE AND ADD** – create a new folder/device which is equivalent to the folder/device where the result of the previously performed measurement was saved,



**SAVE TO THE PREVIOUS ONE** save the result in the folder/device where the result of the previously performed measurement was saved.

## 6.2 $I_{\Delta}$ – differential leakage current

Differential leakage current  $I_{\Delta}$  is, according to Kirchoff's first law, the difference of the values of the currents flowing in L and N wires of the test object in operation. The measurement enables determining the total leakage current of the object, i.e. the sum of all leaking currents, not only the one flowing through the protective conductor (for class I equipment). The measurement is performed as a replacement of the insulation resistance measurement.

To take a measurement, you must set ( $\text{☰}$ ):

- whether the measurement is continuous or not ( $\infty$  = **yes** – the test is continued until the **STOP** button is pressed,  $\infty$  = **no** – time **t** is respected),
- test duration **t**,
- change polarity (**yes** – if the measurement is to be repeated for reverse polarity, **no** – if the measurement is performed for only one polarity),
- test method,
- limit (if necessary).



### WARNING

- During the measurement, the same mains voltage is present at the measuring socket which powers the tested appliance.
- During the measurement of a faulty appliance, RCD switch may be triggered off.

1



- Select  $I_{\Delta}$  measurement.
- Enter the measurement settings (**sec. 2.3**).

2

Connect the measuring system according to the selected method:

- measurement with test socket – according to **sec. 3.2.4**,
- measurement with clamp – according to **sec. 3.2.2**,
- measurement of PRCD – according to **sec. 3.2.9**.

3



Press **START** button.

Testing will continue **until it reaches the preset time** or until  is pressed.



Touching the bar with the result reveals partial results.



4

After the measurement is completed, you can read the result. Touching the bar with the result will now also reveal partial results.

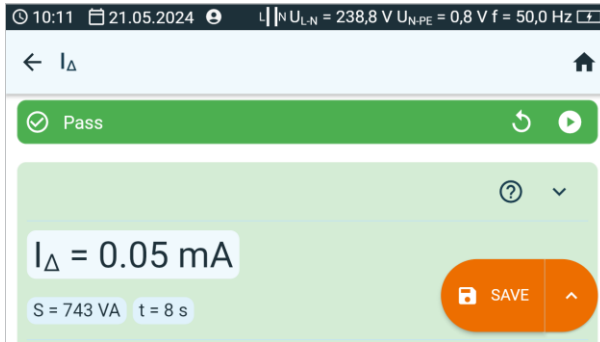

5

You may do the following with the measurement result:



ignore and exit to the measurement menu,

repeat it (the selection window for the measurement you want to repeat will be shown),



**SAVE** – save to memory,



▶ **SAVE AND ADD** – create a new folder/device which is equivalent to the folder/device where the result of the previously performed measurement was saved,



▶ **SAVE TO THE PREVIOUS ONE** save the result in the folder/device where the result of the previously performed measurement was saved.



- Differential leakage current is measured as a difference between L current and N current. This measurement takes into account not only current leaking to PE, but also currents leaking to other earthed elements - e.g. water pipe. The disadvantage of this measurement is the presence of common current (supplied to the tested appliance through L line and returning via N line), which influences the measurement accuracy. If this current is high, the measurement will be less accurate than the measurement of PE leakage current.
- The tested appliance must be turned on.
- When **Change polarity** is set on **Yes**, after the set time duration is over the tester automatically changes the polarity of the test mains socket and resumes the test. As a test result it displays the value of the higher leakage current.
- The result of measurement may be affected by the presence of external fields and by the current used by the appliance.
- If the tested appliance is damaged, signaling a 16 A fuse burnout may also mean that the overcurrent protection device in the mains from which the meter is powered has tripped.

## 6.3 $I_L$ – welding circuit leakage current

$I_L$  current is the leakage current between the welding clamps and the protective conductor's connector.

To take a measurement, you must set (☰):

- test duration  $t$ ,
- change polarity (**yes** – if the measurement is to be repeated for reverse polarity, **no** – if the measurement is performed for only one polarity),
- test method,
- limit (if necessary).

1



- Select  $I_L$  measurement.
- Enter the measurement settings (**sec. 2.3**).

2

Connect the measuring system according to the selected method:

- testing of 1-phase appliance – measurement with test socket – according to **sec. 3.2.12.1**,
- testing of 3-phase appliance – according to **sec. 3.2.12.5**.

3



Press **START** button.

Testing will continue **until it reaches the preset time** or until  is pressed.



Touching the bar with the result reveals partial results.

4

After the measurement is completed, you can read the result. Touching the bar with the result will now also reveal partial results.

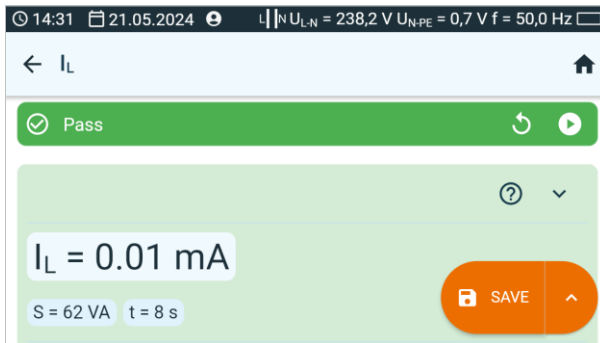

# 5

You may do the following with the measurement result:



ignore and exit to the measurement menu,  
repeat it (the selection window for the measurement you want to repeat will be shown),



**SAVE** – save to memory,



**SAVE AND ADD** – create a new folder/device which is equivalent to the folder/device where the result of the previously performed measurement was saved,



**SAVE TO THE PREVIOUS ONE** save the result in the folder/device where the result of the previously performed measurement was saved.

## 6.4 I<sub>P</sub> – welding machine power supply circuit leakage current

This is the leakage current in the primary (power) circuit of the welding machine. During the testing, the following is required:

- the welding energy source must be isolated from the ground,
- the welding energy source must be powered using the rated voltage,
- the welding energy source must be connected to the protective earthing via the measurement system exclusively,
- the input circuit must be in the no-load condition,
- the interference suppression capacitors must be disconnected.

To take a measurement, you must set (☰):

- whether the measurement is continuous or not (∞ = **yes** – the test is continued until the **STOP** button is pressed, ∞ = **no** – time **t** is respected),
- test duration **t**,
- change polarity (**yes** – if the measurement is to be repeated for reverse polarity, **no** – if the measurement is performed for only one polarity),
- test method,
- limit (if necessary).

1



- Select I<sub>P</sub> measurement.
- Enter the measurement settings (**sec. 2.3**).

2

Connect the measuring system according to the selected method:

- measurement with test socket – according to **sec. 3.2.12.2**,
- testing of 1-phase appliance 230 V when it is powered from the mains – according to **sec. 3.2.12.3**,
- testing of 3-phase appliance when it is powered from the mains – according to **sec. 3.2.12.6**.

3



Press **START** button.

Testing will continue **until it reaches the preset time** or until  is pressed.



Touching the bar with the result reveals partial results.

4

After the measurement is completed, you can read the result. Touching the bar with the result will now also reveal partial results.

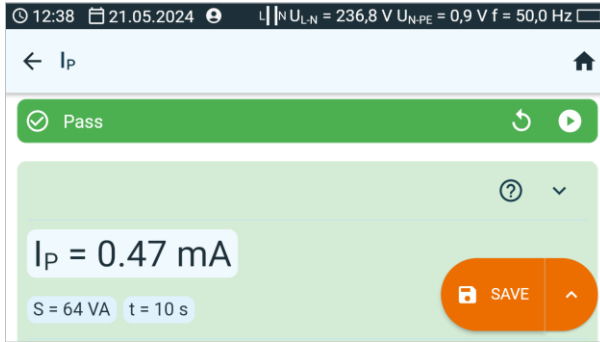

5

You may do the following with the measurement result:



ignore and exit to the measurement menu,

repeat it (the selection window for the measurement you want to repeat will be shown),



**SAVE** – save to memory,



▶ **SAVE AND ADD** – create a new folder/device which is equivalent to the folder/device where the result of the previously performed measurement was saved,



▶ **SAVE TO THE PREVIOUS ONE** save the result in the folder/device where the result of the previously performed measurement was saved.

## 6.5 I<sub>PE</sub> – leakage current in the PE wire

I<sub>PE</sub> current is the current that flows through the protective conductor, when the equipment is in operation. It must not, however, be identified with the total leakage current as other leakage routes may exist in addition to the PE wire. Therefore, during the test, the tested equipment should be separated from the ground.



The measurement only makes sense if the R<sub>PE</sub> measurement was positive.

To take a measurement, you must set ( $\overline{\text{PE}}$ ):

- whether the measurement is continuous or not ( $\infty$  = **yes** – the test is continued until the **STOP** button is pressed,  $\infty$  = **no** – time **t** is respected),
- test duration **t**,
- change polarity (**yes** – if the measurement is to be repeated for reverse polarity, **no** – if the measurement is performed for only one polarity),
- test method,
- limit (if necessary).



### WARNING

- During the measurement, the same mains voltage is present at the measuring socket which powers the tested appliance.
- During the measurement of a faulty appliance, RCD switch may be triggered off.

1



- Select I<sub>PE</sub> measurement.
- Enter the measurement settings (**sec. 2.3**).

2

Connect the measuring system according to the selected method:

- measurement with test socket or clamp – according to **sec. 3.2.3**,
- measurement of PRCD – according to **sec. 3.2.9**.

3



Press **START** button.

Testing will continue **until it reaches the preset time** or until  is pressed.



Touching the bar with the result reveals partial results.

4

After the measurement is completed, you can read the result. Touching the bar with the result will now also reveal partial results.

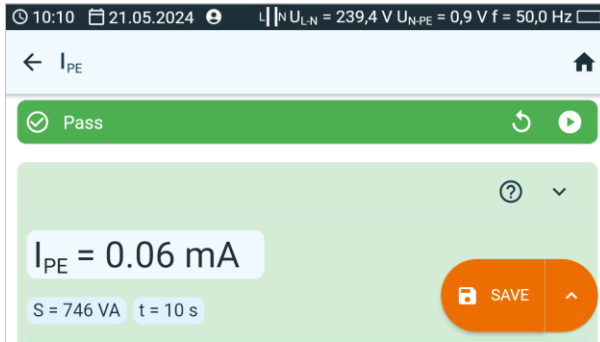

5

You may do the following with the measurement result:



ignore and exit to the measurement menu,

repeat it (the selection window for the measurement you want to repeat will be shown),



**SAVE** – save to memory,



▶ **SAVE AND ADD** – create a new folder/device which is equivalent to the folder/device where the result of the previously performed measurement was saved,



▶ **SAVE TO THE PREVIOUS ONE** save the result in the folder/device where the result of the previously performed measurement was saved.



- PE leakage current is measured directly in PE conductor, which gives an accurate result even if the appliance consumes a current of 10 A or 16 A. Note that if the current does not leak to PE, but to other earthed elements (e.g. water pipe) – it cannot be measured in this measurement function. In that case it is advised that the differential leakage current  $I_{\Delta}$  method of testing should be used.
- Ensure that the location of the tested appliance is insulated.
- When **Change polarity** is set on **Yes**, after the set time duration is over the tester automatically changes the polarity of the test mains socket and resumes the test. As a test result it displays the value of the higher leakage current.
- If the tested appliance is damaged, signaling a 16 A fuse burnout may also mean that the overcurrent protection device in the mains from which the meter is powered has tripped.

## 6.6 I<sub>SUB</sub> – substitute leakage current

Substitute (alternative) leakage current I<sub>SUB</sub> is a theoretical current. The tested equipment is powered from a reduced safe voltage source and the resulting current is scaled up to calculate the current that would flow with the rated power supply (which also makes this measurement the safest for the tester operator). The substitute current measurement is not applicable to the equipment that requires the full supply voltage for start-up.



- For Class I appliances, the measurement only makes sense if the R<sub>PE</sub> measurement was positive.
- I<sub>SUB</sub> current is measured at <50 V voltage. The value is rescaled to the nominal mains voltage value that is set in the menu (see **sec. 1.5.5**). The voltage is applied between L and N (that are shorted), and PE. The resistance of the measuring circuit is 2 kΩ.

To take a measurement, you must set (☞):

- test duration t,
- test method,
- whether the measurement is continuous or not (∞ = **yes** – the test is continued until the **STOP** button is pressed, ∞ = **no** – time t is respected),
- limit (if necessary).

1



- Select I<sub>SUB</sub> measurement.
- Enter the measurement settings (**sec. 2.3**).

2

Connect the measuring system according to the protection class of the tested device:

- Class I – according to **sec. 3.2.4**,
- Class II – according to **sec. 3.2.5**.

3



Press **START** button.

Testing will continue **until it reaches the preset time** or until  is pressed.



Touching the bar with the result reveals partial results.

4

After the measurement is completed, you can read the result. Touching the bar with the result will now also reveal partial results.

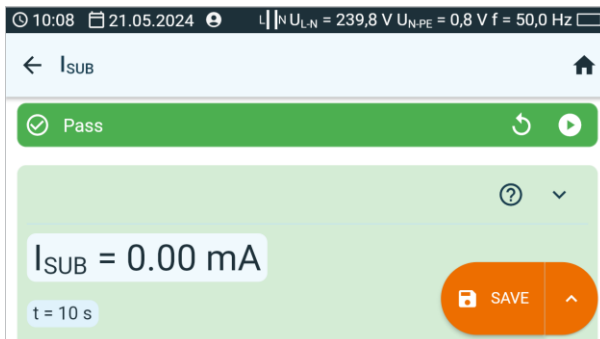



# 5

You may do the following with the measurement result:



ignore and exit to the measurement menu,  
repeat it (the selection window for the measurement you want to repeat will be shown),



**SAVE** – save to memory,



**SAVE AND ADD** – create a new folder/device which is equivalent to the folder/device where the result of the previously performed measurement was saved,



**SAVE TO THE PREVIOUS ONE** save the result in the folder/device where the result of the previously performed measurement was saved.



- Tested appliance must be turned on.
- Test circuit is electrically isolated from the mains and from mains' PE lead.
- Test voltage is 25 V...50 V RMS.

## 6.7 I<sub>T</sub> – touch leakage current

I<sub>T</sub> touch leakage current is the current flowing to the ground from a component insulated from the power supply circuit, when this component is shorted. This value is associated with the corrected touch current. This is the touch current that flows to earth through a probe simulating the resistance of a human being. The IEC 60990 standard gives a human resistance of 2 kΩ, and this is also the internal resistance of the probe.

To take a measurement, you must set (☞):

- whether the measurement is continuous or not (∞ = **yes** – the test is continued until the **STOP** button is pressed, 0 = **no** – time **t** is respected),
- test duration **t**,
- change polarity (**yes** – if the measurement is to be repeated for reverse polarity, **no** – if the measurement is performed for only one polarity),
- test method,
- limit (if necessary).



### WARNING

- During the measurement, the same mains voltage is present at the measuring socket which powers the tested appliance.
- During the measurement of a faulty appliance, RCD switch may be triggered off.

1



- Select I<sub>T</sub> measurement.
- Enter the measurement settings (**sec. 2.3**).

2

Connect the measuring system according to the selected method:

- measurement with probe – according to **sec. 3.2.5**,
- measurement of PRCD – according to **sec. 3.2.9**.

3



Press **START** button.

Testing will continue **until it reaches the preset time** or until  is pressed.



Touching the bar with the result reveals partial results.

4

After the measurement is completed, you can read the result. Touching the bar with the result will now also reveal partial results.

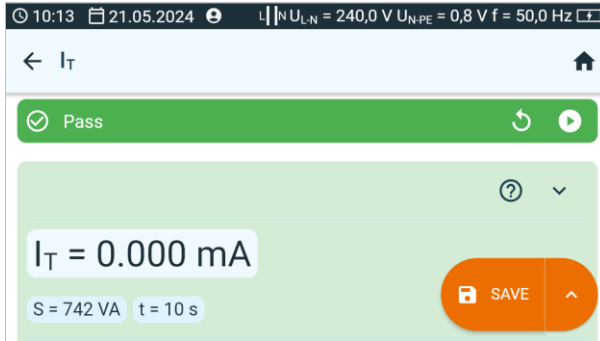

5

You may do the following with the measurement result:



ignore and exit to the measurement menu,

repeat it (the selection window for the measurement you want to repeat will be shown),



**SAVE** – save to memory,



▶ **SAVE AND ADD** – create a new folder/device which is equivalent to the folder/device where the result of the previously performed measurement was saved,



▶ **SAVE TO THE PREVIOUS ONE** save the result in the folder/device where the result of the previously performed measurement was saved.



- When **Change polarity** is set on **Yes**, after the set time duration is over the tester automatically changes the polarity of the test mains socket and resumes the test. As a test result it displays the value of the higher leakage current.
- When tested appliance is powered from other socket, the measurement should be performed at both mains plug positions and as the result the higher current value should be accepted. When the appliance is powered from the tester's socket in auto tests, L and N terminals are swapped by the tester.
- The bandwidth of test current results from the measuring system with adjusted touch current which simulates human perception and reaction, in accordance with IEC 60990.

## 6.8 IEC – IEC cord test

The test includes checking wires continuity, short circuits between the wires, correctness of L-L and N-N connection, PE resistance and insulation resistance measurement.

To take a measurement, you must set (☞):

- measurement duration for  $R_{PE}$  resistance –  $t$ ,
- test current  $I_n$ ,
- $R_{PE}$  limit (maximum resistance of the PE lead),
- measurement duration for  $R_{ISO}$  resistance –  $t$ ,
- test voltage –  $U_n$ ,
- $R_{ISO}$  limit (minimum insulation resistance),
- change polarity (**yes** – if the measurement is to be repeated for reverse polarity, **no** – if the measurement is performed for only one polarity).



- The selection of the polarization test mode depends on whether the test is carried out on a standard IEC cable (**LV** method) or a cable equipped with an RCD (**HV** method).
- During the polarity test in HV mode, the RCD will trip. It must be switched on within 10 seconds. Otherwise, the meter treats this as a broken circuit and returns a negative measurement result.

1



- Select **IEC** measurement.
- Enter the measurement settings (**sec. 2.3**).

2

Connect the measuring system according to the selected method:

- IEC measurement (LV) – according to **sec. 3.2.8**,
- PRCD measurement (HV) – according to **sec. 3.2.9**.

3



Press **START** button.

Testing will continue **until it reaches the preset time** or until  is pressed.



Touching the bar with the result reveals partial results.

4

After the measurement is completed, you can read the result. Touching the bar with the result will now also reveal partial results.

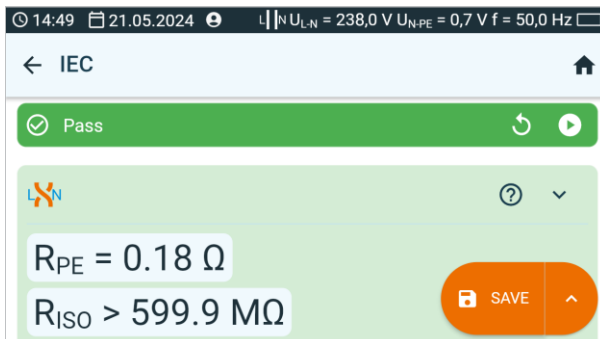

Information about irregularities in the lead are displayed in the test results field.

# 5

You may do the following with the measurement result:



ignore and exit to the measurement menu,  
repeat it (the selection window for the measurement you want to repeat will be shown),



**SAVE** – save to memory,



**SAVE AND ADD** – create a new folder/device which is equivalent to the folder/device where the result of the previously performed measurement was saved,



**SAVE TO THE PREVIOUS ONE** save the result in the folder/device where the result of the previously performed measurement was saved.

## 6.9 PELV – test of PELV appliances

The test consists in checking whether the source generates extra-low voltage within limits.

To take a measurement, you must set (☰):

- whether the measurement is continuous or not ( $\infty$  = **yes** – the test is continued until the **STOP** button is pressed,  $\infty$  = **no** – time **t** is respected),
- test duration **t**,
- lower limit,
- upper limit.

1



- Select **PELV** measurement.
- Enter the measurement settings (**sec. 2.3**).

2

Connect the measuring system according to **sec. 3.2.10**.

3



Press **START** button.

Testing will continue **until it reaches the preset time** or until  is pressed.



Touching the bar with the result reveals partial results.

4

After the measurement is completed, you can read the result. Touching the bar with the result will now also reveal partial results.

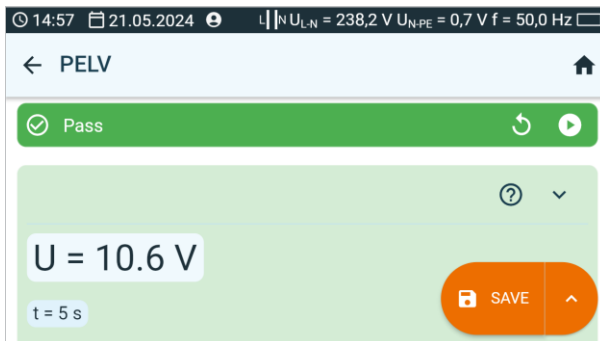

# 5

You may do the following with the measurement result:



ignore and exit to the measurement menu,  
repeat it (the selection window for the measurement you want to repeat will be shown),



**SAVE** – save to memory,



**SAVE AND ADD** – create a new folder/device which is equivalent to the folder/device where the result of the previously performed measurement was saved,



**SAVE TO THE PREVIOUS ONE** save the result in the folder/device where the result of the previously performed measurement was saved.

## 6.10 PRCD – testing PRCD devices (with built-in RCD)

Per the EN 50678 standard for equipment with additional protection measures like RCD, PRCD or other switches, the switch activation test must be performed according to its specification and characteristics. One should look for the detailed information on the housing or in the technical documentation. The measurement procedure contains polarity check of the cord.

To take a measurement, you must set (☰):

- **waveform** (shape of the test current),
- test type (tripping current  $I_A$  or tripping time at a given multiplication factor of rated current  $t_A$ ),
- RCD nominal current –  $I_{\Delta n}$ ,
- type of the tested circuit breaker – **RCD**.



### WARNING

During the measurement, the same mains voltage is present at the measuring socket which powers the tested appliance.

1



- Select **PRCD** measurement.
- Enter the measurement settings (**sec. 2.3**).

2

Connect the tested object according to **sec. 3.2.9**.

3



Press **START** button.

Testing will continue **until it reaches the preset time** or until  is pressed.



Touching the bar with the result reveals partial results.

4

After the measurement is completed, you can read the result. Touching the bar with the result will now also reveal partial results.

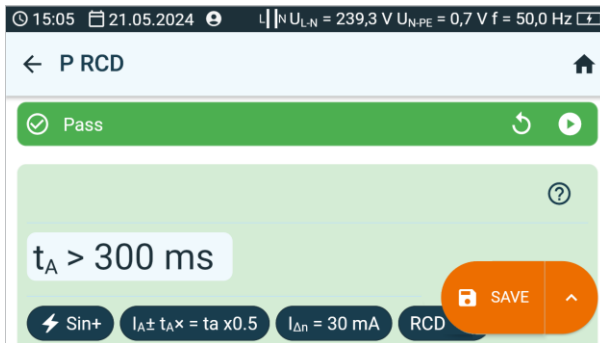



# 5

You may do the following with the measurement result:



- ignore and exit to the measurement menu,
- repeat it (the selection window for the measurement you want to repeat will be shown),



▶ **SAVE** – save to memory,



▶ **SAVE AND ADD** – create a new folder/device which is equivalent to the folder/device where the result of the previously performed measurement was saved,



▶ **SAVE TO THE PREVIOUS ONE** save the result in the folder/device where the result of the previously performed measurement was saved.

## 6.11 RCD – measurement of fixed RCD parameters

Per the EN 50678 standard for equipment with additional protection measures like RCD, PRCD or other switches, the switch activation test must be performed according to its specification and characteristics. One should look for the detailed information on the housing or in the technical documentation.

To take a measurement, you must set (☰):

- **waveform** (shape of the test current),
- test type (tripping current  $I_a$  or tripping time at a given multiplication factor of rated current  $t_a$ ),
- RCD nominal current –  $I_{\Delta n}$ ,
- type of the tested circuit breaker – **RCD**.

1



- Select **RCD** measurement.
- Enter the measurement settings (**sec. 2.3**).

2

Connect the measuring system according to **sec. 3.2.11**.

3



Press **START** button.



Switch on the RCD every time it trips.



Touching the bar with the result reveals partial results.

4

After the measurement is completed, you can read the result. Touching the bar with the result will now also reveal partial results.

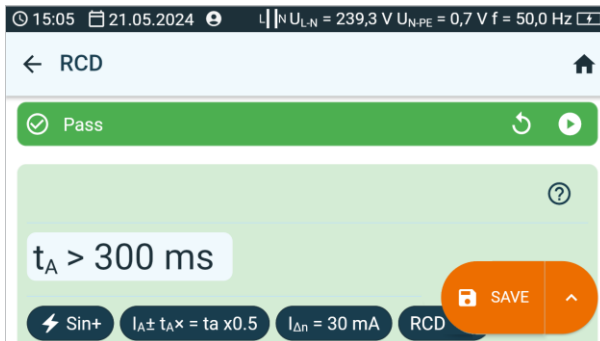

# 5

You may do the following with the measurement result:



ignore and exit to the measurement menu,  
repeat it (the selection window for the measurement you want to repeat will be shown),



**SAVE** – save to memory,



**SAVE AND ADD** – create a new folder/device which is equivalent to the folder/device where the result of the previously performed measurement was saved,



**SAVE TO THE PREVIOUS ONE** save the result in the folder/device where the result of the previously performed measurement was saved.

## 6.12 R<sub>ISO</sub> – insulation resistance

Insulation constitutes the basic form of protection and determines the safety of the device's use in Class I and Class II. The scope of the check must encompass the power supply cable. The measurement should be performed using 500 V DC. For devices with built-in surge protectors, SELV/PELV devices and IT equipment, testing should be carried out with a voltage reduced to 250 V DC.



The measurement only makes sense if the R<sub>PE</sub> measurement was positive.

To take a measurement, you must set ( $\overline{\text{SET}}$ ):

- test duration **t**,
- test voltage **U<sub>n</sub>**,
- test method,
- whether the measurement is continuous or not (**∞** = **yes** – the test is continued until the **STOP** button is pressed, **∞** = **no** – time **t** is respected),
- limit (if necessary).



- Tested appliance must be turned on.
- Test circuit is electrically isolated from the mains and from mains' PE lead.
- Test result should be read only after displayed values are stabilized.
- After the measurement the tested object is automatically discharged.

1



- Select **R<sub>ISO</sub>** measurement.
- Enter the measurement settings (**sec. 2.3**).

2

Connect the measuring system according to the tested object:

- Class I appliance – **socket** method – according to **sec. 3.2.4**,
- Class I appliance – **probe-probe** method – according to **sec. 3.2.6**,
- Class II or III appliance – **socket-probe** method – according to **sec. 3.2.5**,
- IEC cord – **IEC** method – according to **sec. 3.2.8**.

3



Press **START** button.

Testing will continue **until it reaches the preset time** or until  is pressed.



Touching the bar with the result reveals partial results.

4

After the measurement is completed, you can read the result. Touching the bar with the result will now also reveal partial results.

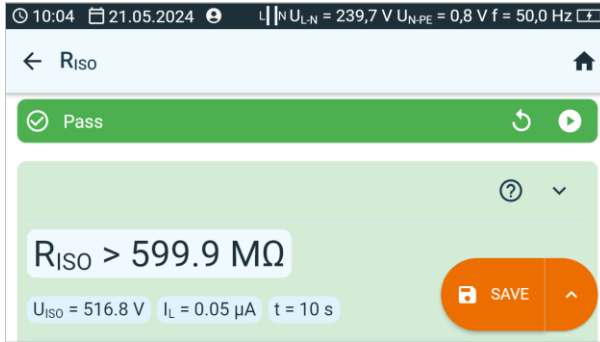

5

You may do the following with the measurement result:



ignore and exit to the measurement menu,

repeat it (the selection window for the measurement you want to repeat will be shown),



**SAVE** – save to memory,



▶ **SAVE AND ADD** – create a new folder/device which is equivalent to the folder/device where the result of the previously performed measurement was saved,



▶ **SAVE TO THE PREVIOUS ONE** save the result in the folder/device where the result of the previously performed measurement was saved.

## 6.13 R<sub>ISO LN-S</sub>, R<sub>ISO PE-S</sub> – insulation resistance in welding machines

Welding machine insulation resistance testing is divided into multiple stages.

- Measuring the insulation resistance between the power supply circuit and the welding circuit.
- Measuring the insulation resistance between the power supply circuit and the protective circuit.
- Measuring the insulation resistance between the welding circuit and the protective circuit.
- Measuring the insulation resistance between the power supply circuit and the exposed conductive parts (for Class II protection).

Tests consist of measuring insulation resistance:

- between shorted primary side conductors (L and N) and secondary winding of the welding machine (**R<sub>ISO LN-S</sub>**),
- between the PE conductor and the secondary winding of the welding machine (**R<sub>ISO PE-S</sub>**).



For Class I appliances, the measurement only makes sense if:

- the R<sub>PE</sub> measurement was positive and
- the standard R<sub>ISO</sub> measurement was positive.

To take a measurement, you must set (☞):

- test duration **t**,
- test voltage **U<sub>n</sub>**,
- whether the measurement is continuous or not (**∞ = yes** – the test is continued until the **STOP** button is pressed, **∞ = no** – time **t** is respected),
- limit (if necessary).



- Tested appliance must be turned on.
- Test circuit is electrically isolated from the mains and from mains' PE lead.
- Test result should be read only after displayed values are stabilized.
- After the measurement the tested object is automatically discharged.

1



- Select **R<sub>ISO LN-S</sub>** or **R<sub>ISO PE-S</sub>** measurement.
- Enter the measurement settings (**sec. 2.3**).

2

Connect the measuring system according to the tested object:

- **R<sub>ISO LN-S</sub>** or **R<sub>ISO PE-S</sub>** measurement. 1-phase appliance – according to **sec. 3.2.12.1**,
- **R<sub>ISO LN-S</sub>** or **R<sub>ISO PE-S</sub>** measurement. 3-phase appliance or 1-phase appliance that is powered by an industrial socket – according to **sec. 3.2.12.4**.

3



Press **START** button.

Testing will continue **until it reaches the preset time** or until  is pressed.



Touching the bar with the result reveals partial results.

4

After the measurement is completed, you can read the result. Touching the bar with the result will now also reveal partial results.

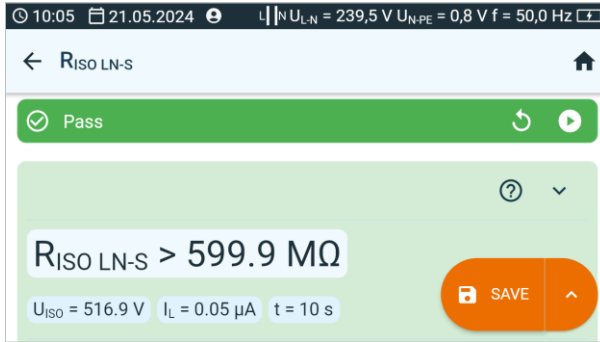

5

You may do the following with the measurement result:



ignore and exit to the measurement menu,

repeat it (the selection window for the measurement you want to repeat will be shown),



**SAVE** – save to memory,



▶ **SAVE AND ADD** – create a new folder/device which is equivalent to the folder/device where the result of the previously performed measurement was saved,



▶ **SAVE TO THE PREVIOUS ONE** save the result in the folder/device where the result of the previously performed measurement was saved.

## 6.14 R<sub>PE</sub> – protective conductor resistance

### 6.14.1 Autozero – calibration of test leads

In order to eliminate the impact of the resistance of test leads on measurement result, the compensation (nulling) of their resistance may be performed.

1



Select **Autozero**.

2a

To **enable** cable resistance compensation, connect the cable to the **T2** socket and to the PE of the **TEST** socket and press . The meter will determine the resistance of the test leads for 25 A and 200 mA currents. As part of the measurements, it will provide **results minus this resistance**, and the **Autozero (On)** message will appear in the resistance measurement window.

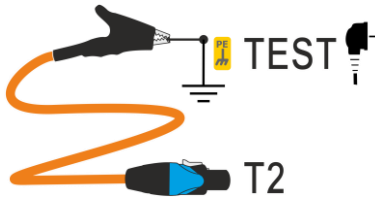

2b

To **enable** cable resistance compensation, disconnect the cable from PE of the **TEST** socket and press . As part of the measurements, the results will **include the resistance of the test leads**, while the resistance measurement window will show the **Autozero (Off)** message.

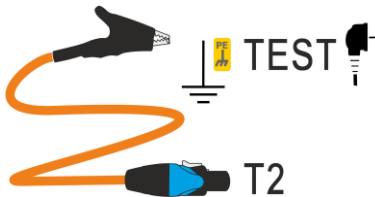



## 6.14.2 R<sub>PE</sub> – protective conductor resistance

A continuity check – or, in other words, a measurement of the protective conductor's resistance – is carried out to verify if the available conductive components are connected properly. In other words, the aspect measured is the resistance between the protective contact of the plug (for permanently-connected devices, the connection point) and the metal parts of the device's housing, which should be connected to the PE wire. This test is performed for Class I devices.

At the same time, it should be noted that also there are devices equipped with a PE wire in Class II as well. This is functional earthing. Most commonly, it is not possible to check for continuity without dismantling the device. In such situations, only Class II-specific tests are to be performed.

To take a measurement, you must set (☰):

- test duration  $t$ ,
- test method,
- rated current  $I_n$  of the tested object,
- whether the measurement is continuous or not ( $\infty = \text{yes}$  – the test is continued until the **STOP** button is pressed,  $\infty = \text{no}$  – time  $t$  is respected),
- limit (if necessary).

1



- Select **R<sub>PE</sub>** measurement.
- Enter the measurement settings (**sec. 2.3**).

2

Connect the measuring system according to the selected method:

- socket-probe or probe- probe – according to **sec. 3.2.7**,
- measurement of IEC cord – according to **sec. 3.2.8**,
- measurement of PRCD – according to **sec. 3.2.9**.

3



Press **START** button.

Testing will continue **until it reaches the preset time** or until  is pressed.



Touching the bar with the result reveals partial results.

4

After the measurement is completed, you can read the result. Touching the bar with the result will now also reveal partial results.

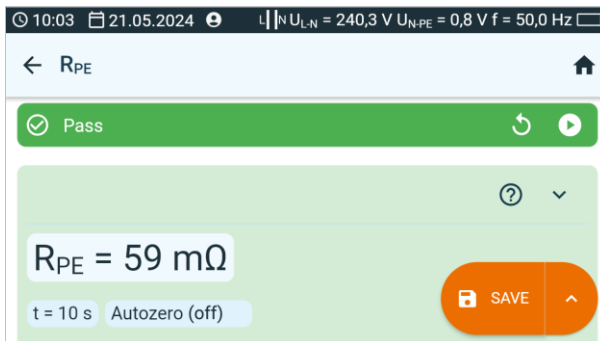

# 5

You may do the following with the measurement result:



ignore and exit to the measurement menu,  
repeat it (the selection window for the measurement you want to repeat will be shown),



**SAVE** – save to memory,



**SAVE AND ADD** – create a new folder/device which is equivalent to the folder/device where the result of the previously performed measurement was saved,



**SAVE TO THE PREVIOUS ONE** save the result in the folder/device where the result of the previously performed measurement was saved.

## 6.15 U<sub>0</sub> – welding machine voltage without load

When the welding machine is powered using the rated voltage at the rated frequency, the peak values of the no-load voltage (U<sub>0</sub>) generated by the machine should not exceed the values given on the nameplate at either of the possible machine settings. Measurements of two quantities are distinguished: PEAK and RMS. Check that the PEAK voltage value meets the ±15% welder U<sub>N</sub> value condition, and that it does not exceed the values given in Table 13 of the IEC 60974-1\_2018-11 standard.

To take a measurement, you must set (☞):

- secondary voltage of the welder **U<sub>0</sub>**, read from its nameplate,
- secondary voltage type of the welding machine,
- RMS limit (if you selected voltage type = AC),
- PEAK limit (if you selected voltage type = AC or DC),
- limit-rated voltage of the primary side of the welding machine – only if you want to check the **±15% PEAK** criterion (lack of entered value disables the control).



- In Limit PEAK and Limit RMS fields select the acceptable values. Both parameters are changing at the same time, as they are interrelated by the following relationship:

$$\text{limit PEAK} = \sqrt{2} \cdot \text{limit RMS}$$

...wherein, if voltage = DC, then Limit RMS is disabled.

- **±15% PEAK** field is responsible for checking whether the measured U<sub>0</sub>voltage is within the limits defined by the standard.
  - If voltage = AC, then U<sub>0</sub>(PEAK) is checked.
  - If voltage = DC, then U<sub>0</sub>(RMS) is checked.

1



- Select **U<sub>0</sub>** measurement.
- Enter the measurement settings (**sec. 2.3**).

2

Connect the measuring system depending on how the welding machine is powered:

- 1-phase welding machine – according to **sec. 3.2.12.1**,
- 3-phase welding machine – according to **sec. 3.2.12.5**.

3



Press **START** button.

Testing will continue **until it reaches the preset time** or until  is pressed.



Touching the bar with the result reveals partial results.

# 4

After the measurement is completed, you can read the result. Touching the bar with the result will now also reveal partial results.

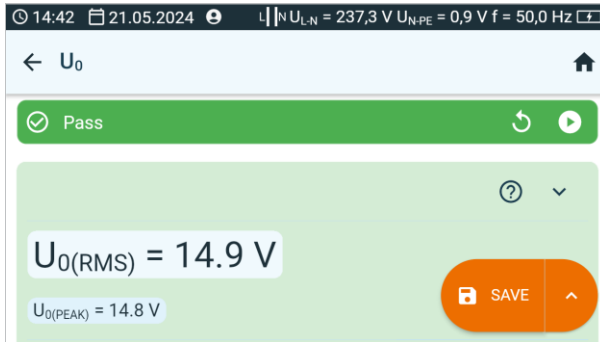

- Positive test result:
  - DC voltage:  $U_0 \leq \text{limit PEAK}$
  - AC, DC voltage:  $U_0 \leq \text{limit RMS}$
  - Optional: the criterion of  $\pm 15\%$  PEAK for AC voltage:
    - $U_0 \leq 115\% \text{ limit PEAK}$
    - $U_0 \geq 85\% \text{ limit PEAK}$
  - Optional: the criterion of  $\pm 15\%$  PEAK for DC voltage:
    - $U_0 \leq 115\% \text{ limit RMS}$
    - $U_0 \geq 85\% \text{ limit RMS}$
- Negative test result:  $U_0$  does not meet at least one of the above conditions.

# 5

You may do the following with the measurement result:



- ignore and exit to the measurement menu,
- repeat it (the selection window for the measurement you want to repeat will be shown),



**SAVE** – save to memory,



▶  **SAVE AND ADD** – create a new folder/device which is equivalent to the folder/device where the result of the previously performed measurement was saved,



▶  **SAVE TO THE PREVIOUS ONE** save the result in the folder/device where the result of the previously performed measurement was saved.

## 6.16 Functional test

Notwithstanding the protection class, finalising the testing procedure requires a functional test – especially following repairs! (per the EN 50678 standard). It entails measuring the following parameters:

- idle current,
- L-N voltage,
- PF coefficient,  $\cos\phi$ , current THD, voltage THD,
- active, reactive and apparent power values.

The measurement values must be compared with the parameters of the nameplate, followed by assessment of the object. Moreover, during the measurement, i.e. when the device is operating, its work culture needs to be assessed. An experienced operator will be able to assess the commutator's condition (whether it flashes or not), bearing wear (sounds and vibrations), as well as detect other faults.



If the tested appliance is damaged, signaling a 16 A fuse burnout may also mean that the overcurrent protection device in the mains from which the meter is powered has tripped.



### WARNING

During the measurement, the same mains voltage is present at the measuring socket which powers the tested appliance.

To take a measurement, you must set (☞):

- whether the measurement is continuous or not ( $\infty$  = **yes** – the test is continued until the **STOP** button is pressed,  $\infty$  = **no** – time **t** is respected),
- test duration **t**,
- test method.

1



- Select **Functional test**.
- Enter the measurement settings (**sec. 2.3**).

2

Connect the measuring system according to **sec. 3.2.13**.

3



Press **START** button.

Testing will continue **until it reaches the preset time** or until  is pressed.



Touching the bar with the result reveals partial results.

4

After the measurement is completed, you can read the result. Touching the bar with the result will now also reveal partial results.

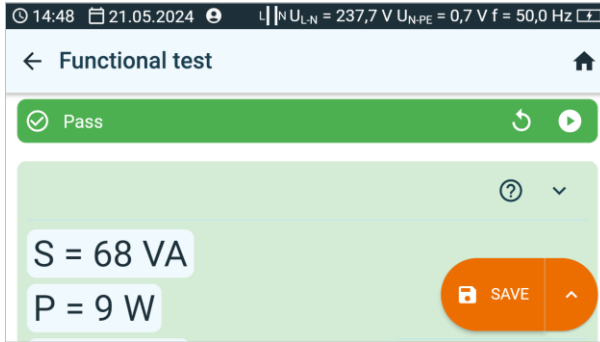

5

Compare the result with the technical data of the tested appliance. The assessment of the correctness of the test results can be performed by selecting the proper field in **Positive test result** or **Negative test result**. When saving test results in the memory, this assessment will also be saved along with the results.

6

You may do the following with the measurement result:



ignore and exit to the measurement menu,

repeat it (the selection window for the measurement you want to repeat will be shown),



**SAVE** – save to memory,



▶ **SAVE AND ADD** – create a new folder/device which is equivalent to the folder/device where the result of the previously performed measurement was saved,



▶ **SAVE TO THE PREVIOUS ONE** save the result in the folder/device where the result of the previously performed measurement was saved.

## 7 Measurements. Photovoltaics

### 7.1 Diode test

This test allows you to check:

- whether the diode correctly withstands the voltage in the conduction (F) direction,
- whether the blocking diode correctly withstands the voltage in the reverse (R) direction.



#### WARNING

During the measurement of the parameters in the reverse direction, the meter generates dangerous measuring voltage.

1



Select **Diode test**.

2



Select test mode:

- F – conduction test,
- R – reverse direction test,
- F, R – conduction and reverse test.

3



For R or F, R test enter the measuring voltage  $U_n$ .

4

Connect test leads according to **sec. 3.3.1** or **sec. 3.3.2**.

5



Press **START** button.

6

After the measurement is completed, you can read the result. Touching the bar with the result will reveal partial results.

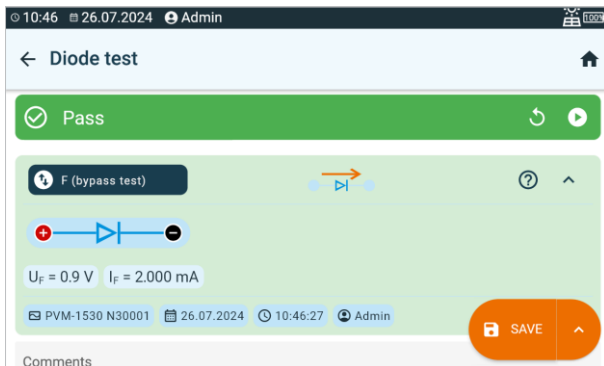

If the measured diode is OK, the measured diode parameters will be displayed. Otherwise, symbols informing about its damage (short-circuit or opening) will be displayed.

$U_{ISO}$  – reverse measurement voltage

$U_F$  – voltage across the diode in the forward direction

$U_R$  – voltage across the diode in the reverse direction

$I_F$  – diode current in the forward direction

$I_R$  – diode current in reverse direction

7

You may do the following with the measurement result:



ignore and exit to the measurement menu,

repeat it (the selection window for the measurement you want to repeat will be shown),



**SAVE** – save to memory,



▶ **SAVE AND ADD** – create a new folder/device which is equivalent to the folder/device where the result of the previously performed measurement was saved,



▶ **SAVE TO THE PREVIOUS ONE** save the result in the folder/device where the result of the previously performed measurement was saved.



During the measurement of the parameters, the correctness of the diode connection to the meter is checked. As part of the measurements, with a reverse connection, information about this fact will appear (next to the probe symbols, information about the polarity of the probe connected to the appropriate tip of the measured diode will be displayed).



## 7.2 I-U – I-U curve

The device measures the current and voltage of the PV system depending on the simulated load, i.e. determines its efficiency. The results are presented in the form of an I-U curve. Based on this, it can be determined whether, or by how much, the performance has deteriorated compared to the rated parameters of the system.

To take a measurement, you must set (☰):

- installation layout (here you need to enter the number of PV modules connected in parallel and series),
- type of photovoltaic panel (selection from the PV panel database according to **sec. 10.1**. If you do not select anything, the measurement result will not be assessed),
- information whether the installation is new,
- age of the installation if it is not new.

1



- Select **I-U curve** measurement.
- Enter the measurement settings (**sec. 2.3**).

2

Connect test leads according to **sec. 3.3.4**.



If the measured installation parameters are below the threshold values, the background of the current readings field will be orange. However, it will still be possible to take the measurement.

3



Press **START** button.

4

After the measurement is completed, the I-U curve appears along with the measured and calculated parameters.



- Using the options on the top bar, you can display the data set to be presented.
- You can enlarge the graph by touching it.

$I_{sc}$  – DC short-circuit current

$I_{sc\ STC}$  – DC short circuit current converted to Standard Test Conditions (STC)

$U_{oc}$  – open circuit DC voltage

$U_{oc\ STC}$  – open circuit voltage converted to STC

$P_{max}$  – maximum power

$P_{max\ STC}$  – maximum power converted to STC

$I_{mpp}$  – current in maximum power point

$U_{mpp}$  – voltage in maximum power point



In addition to the parameters directly related to the curve, additional parameters are also provided.

- **FF** (Fill Factor) – fill factor expressed as:

$$FF = \frac{I_{MPP} \cdot U_{MPP}}{I_{SC} \cdot U_{OC}}$$

- **PF** (Power Factor) [%] – power factor expressed as:

$$PF = \frac{P_{MAXSTC \text{ calculated}}}{P_{MAXSTC \text{ from specifications}}} \cdot 100\%$$

- **AF** (Age Factor) – age factor expressed as:

$$AF = \frac{P_{MAXSTC \text{ calculated}}}{P_{MAXSTC \text{ from specifications}} \left(1 - \frac{\% \text{ of degradation per year}}{100} \cdot \text{age of the installation}\right)} \cdot 100$$

- **ΔE** [%] – solar radiation error, i.e. the difference in solar radiation measured by the reference IRM-1 before and after the I-U curve measurement (difference no greater than 2%)
- **ΔT** [°C or °F] – difference in temperature measured by the reference IRM-1 before and after measuring the I-U curve (difference no greater than 1°C or 1.8°F)
- **ΔEs** [%] – difference in solar radiation measured by the reference IRM-1 and the auxiliary IRM-1 during the measurement of the I-U curve
- **R<sub>SER</sub>** [Ω] – series resistance of panels
- **R<sub>PAR</sub>** [Ω] – parallel resistance of panels

## 5

You may do the following with the measurement result:



ignore and exit to the measurement menu,



repeat it (the selection window for the measurement you want to repeat will be shown),



**SAVE** – save to memory,



**SAVE AND ADD** – create a new folder/device which is equivalent to the folder/device where the result of the previously performed measurement was saved,



**SAVE TO THE PREVIOUS ONE** save the result in the folder/device where the result of the previously performed measurement was saved.

## 7.3 I<sub>Clamp</sub> – current clamp measurement

The device measures the operating current of the PV installation. The test can be used as an alternative to measuring the short circuit current  $I_{SC}$ , when the latter test cannot be performed for some reason. The test also allows you to check the current consumption of AC/DC electrical devices.

1



Select I<sub>Clamp</sub> measurement.

2

Connect the clamp according to **sec. 3.3.3**.

3

The current readings will appear on the screen.

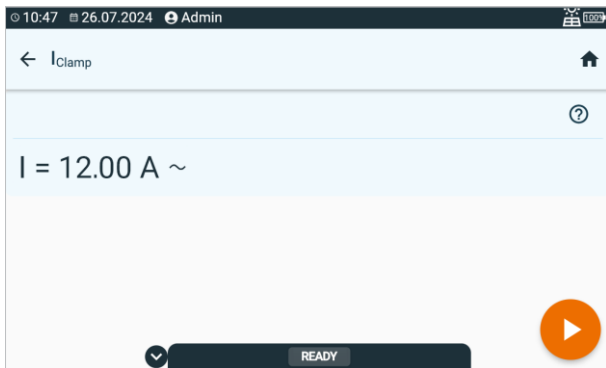

4



Press **START** button to enable the result to be written to memory.

5

You may do the following with the measurement result:



ignore and exit to the measurement menu,

repeat it (the selection window for the measurement you want to repeat will be shown),



**SAVE** – save to memory,



**SAVE AND ADD** – create a new folder/device which is equivalent to the folder/device where the result of the previously performed measurement was saved,



**SAVE TO THE PREVIOUS ONE** save the result in the folder/device where the result of the previously performed measurement was saved.

## 7.4 I<sub>SC</sub> – DC short circuit current

I<sub>SC</sub> is the current generated by a PV installation when the DC side is shorted.

To take a measurement, you must set (☰):

- installation layout (here you need to enter the number of PV modules connected in parallel and series),
- type of photovoltaic panel (selection from the database according to **sec. 10.1**. You can also perform the measurement without selecting the panel from the database, but then the measurement result will not be assessed),
- I<sub>SC TO L</sub> tolerance within which the I<sub>SC</sub> (expressed in %).



### NOTE!

During the measurement, the photovoltaic system is short-circuited for a short time. The test leads must not be disconnected during the measurement – there is a risk of electric arc ignition and damage to the meter.

1



- Select I<sub>SC</sub> measurement.
- Enter the measurement settings (**sec. 2.3**).

2

Connect test leads according to **sec. 3.3.4**. The meter is ready for measurement if it detects voltage  $U_{DC} \geq 10 \text{ V}$  on the object.

3



Press **START** button.

4

After the measurement is completed, you can read the result. Touching the bar with the result will reveal partial results.

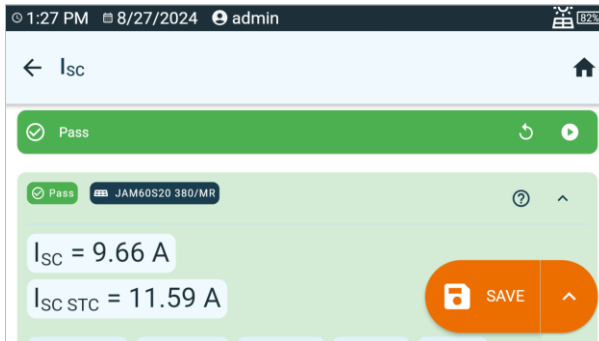

I<sub>SC</sub> – measured short circuit current

I<sub>SC STC</sub> – measured I<sub>SC</sub> current converted to STC

E<sub>1</sub> – solar irradiance of the tested object no. 1

E<sub>2</sub> – solar irradiance of the tested object no. 2

T<sub>PV1</sub> – temperature of tested object no. 1

T<sub>PV2</sub> – temperature of tested object no. 2

# 5

You may do the following with the measurement result:



ignore and exit to the measurement menu,  
repeat it (the selection window for the measurement you want to repeat will be shown),



**SAVE** – save to memory,



**SAVE AND ADD** – create a new folder/device which is equivalent to the folder/device where the result of the previously performed measurement was saved,



**SAVE TO THE PREVIOUS ONE** save the result in the folder/device where the result of the previously performed measurement was saved.



The result will not be assessed if:

- it has not been converted to Standard Test Conditions (STC),
- the measurement was performed without selecting the type of photovoltaic panel.

## 7.5 P – power measurement

The measurement enables the determination of the consumption or generation of active power by electrical devices. Applies to AC and DC devices.

1



Select **Power**.

2

Connect the measuring system according to **sec. 3.3.5**.

3

The current readings will appear on the screen.



I – current measured by clamps

4



Press **START** button to enable the result to be written to memory.

5

You may do the following with the measurement result:



ignore and exit to the measurement menu,

repeat it (the selection window for the measurement you want to repeat will be shown),



**SAVE** – save to memory,



**SAVE AND ADD** – create a new folder/device which is equivalent to the folder/device where the result of the previously performed measurement was saved,



**SAVE TO THE PREVIOUS ONE** save the result in the folder/device where the result of the previously performed measurement was saved.

## 7.6 R<sub>ISO</sub> – insulation resistance

The instrument measures the insulation resistance by applying the measuring voltage  $U_n$  to the tested resistance  $R$  and measuring the current  $I$  flowing through it. When calculating the value of the insulation resistance, the meter uses the technical method of resistance measurement ( $R = U/I$ ).

To take a measurement, you must set (☞):

- test voltage  $U_n$ ,
- limits (if necessary).

The meter will suggest possible settings.



### WARNING

The tested object must not be live.

1



- Select **R<sub>ISO</sub>** measurement.
- Enter the measurement settings (**sec. 2.3**).

2

Connect test leads according to **sec. 3.3.6**.

3



Press and hold the **START** button for **5 seconds**. This will trigger a countdown, during which the meter does not generate a dangerous voltage, and the measurement can be interrupted without the need to discharge the tested object. After the countdown, the measurement will **start**.



Quick start (without a delay of 5 seconds) perform by sliding the **START** button.

Testing will continue until  is pressed.



Touching the bar with the result reveals partial results.

4

After the measurement is completed, you can read the result. Touching the bar with the result will now also reveal partial results.

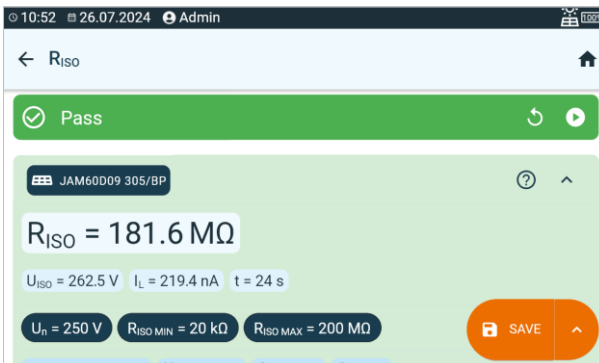

$U_{ISO}$  – test voltage  
 $I_L$  – leakage current  
 $t$  – test duration

# 5

You may do the following with the measurement result:



ignore and exit to the measurement menu,

repeat it (the selection window for the measurement you want to repeat will be shown),



**SAVE** – save to memory,



**SAVE AND ADD** – create a new folder/device which is equivalent to the folder/device where the result of the previously performed measurement was saved,



**SAVE TO THE PREVIOUS ONE** save the result in the folder/device where the result of the previously performed measurement was saved.



- The timer measuring the measurement time is started when  $U_{ISO}$  voltage is stabilized.
- **LIMIT I** informs of an operation with limited inverter power. If this condition persists for 20 seconds, the measurement is stopped.
- If the meter is unable to charge the capacitance of the tested object, **LIMIT I** is displayed and after 20 s **the measurement is stopped**.
- After completion of the measurement, the capacitance of the tested object is discharged by shorting + and - terminals. At the same time, the message **DISCHARGING** is displayed, as well as the value of  $U_{ISO}$  voltage that is present at that time on the object.  $U_{ISO}$  decreases over time until it is fully discharged.



## 7.7 R<sub>ISO</sub> PV – insulation resistance in PV systems



### WARNING

- Before testing the object, restrict access to it by unauthorized persons.
- Do not touch any metal parts of the photovoltaic system and the rear part of the modules during the measurement.
- During measurements of insulation resistance, dangerous voltage is present at the ends of test leads of the meter.
- It is forbidden to disconnect test leads and to change the position of the function switch before completion of measurement. Failure to obey the above instruction will lead to high voltage electric shock and make it impossible to discharge the tested object.

The instrument measures the insulation resistance by applying the measuring voltage  $U_n$  to the tested resistance  $R$  and measuring the current  $I$  flowing through it. When calculating the value of the insulation resistance, the meter uses the technical method of resistance measurement ( $R = U/I$ ).

For systems with one parallel connection it is possible to obtain the ground fault indicator (*GFI*). It indicates which PV panel has a ground fault. The function is activated when the insulation resistance drops below the standard value for a given measuring voltage.

Example: for a system of  $n$  panels connected in series (e.g. 10), we apply a measuring voltage  $U_n=500$  V, and the  $R_{ISO}$  value is lower than the required 1 M $\Omega$ .

- If GFI is 0, then there is a ground fault between the installation "+" terminal and panel #1.
- If GFI is in the range 1... $n-1$  (e.g. 3), then a ground fault may be present between the indicated panel and the next one (here: between panel no. 3 and 4).
- If GFI is  $n$  (e.g. 10), then there is a ground fault between the installation "-" terminal and the last panel.

GFI has two modes.

- Precise mode – active when  $R_{ISO} \in <0; 100>$  k $\Omega$ . There is a **very high** probability of a ground fault between the panels indicated by the meter. Indication: **GFI =**.
- Approximate mode – active when  $R_{ISO} \in (100; 1000)$  k $\Omega$ . There is **some** probability of a ground fault between the panels indicated by the meter. Indication: **GFI  $\approx$** .

To take a measurement, you must set ():

- installation layout (here you need to enter the number of PV modules connected in series and parallel),
- test voltage  $U_n$ ,
- limits (if necessary).

1



- Select **R<sub>ISO</sub> PV** measurement.
- Enter the measurement settings (**sec. 2.3**).

2

Connect the wires according to the appropriate diagram depending on the type of installation being tested. (**sec. 3.3.7**). The meter is ready for measurement if it detects voltage  $U_{DC} \geq 10$  V on the object.

3



Press **START** button.

4

After the measurement is completed, you can read the result. Touching the bar with the result will reveal partial results.

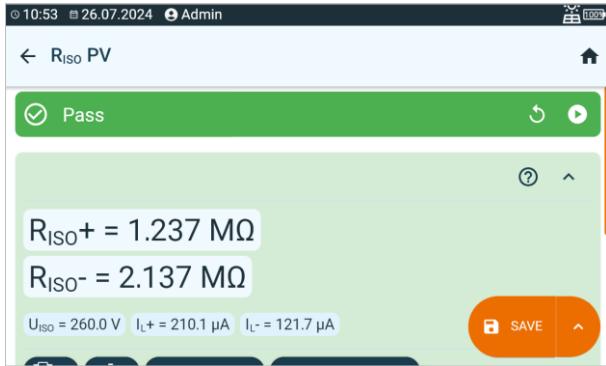

$U_{iso}$  – test voltage

GFI – ground fault indicator

5

You may do the following with the measurement result:



ignore and exit to the measurement menu,

repeat it (the selection window for the measurement you want to repeat will be shown),



**SAVE** – save to memory,



▶ **SAVE AND ADD** – create a new folder/device which is equivalent to the folder/device where the result of the previously performed measurement was saved,



▶ **SAVE TO THE PREVIOUS ONE** save the result in the folder/device where the result of the previously performed measurement was saved.



The meter emits a continuous audio signal until test voltage reaches 90% of the preset value (and also when 110% of the preset value is exceeded).

## 7.8 $U_{OC}$ – DC voltage of open circuit

$U_{OC}$  is the voltage generated by the PV installation when the DC side is open.

To take a measurement, you must set (☰):

- type of photovoltaic panel (selection from the database according to **sec. 10.1**. You can also perform the measurement without selecting the panel from the database, but then the measurement result will not be assessed),
- $U_{OC\,TOL}$  tolerance, within which the  $U_{OC}$  voltage should be kept,
- installation layout (here you need to enter the number of PV modules connected in series and parallel).

1



- Select  $U_{OC}$  measurement.
- Enter the measurement settings (**sec. 2.3**).

2

Connect test leads according to **sec. 3.3.4**.

3

After the measurement is completed, you can read the result. Touching the bar with the result will reveal partial results.

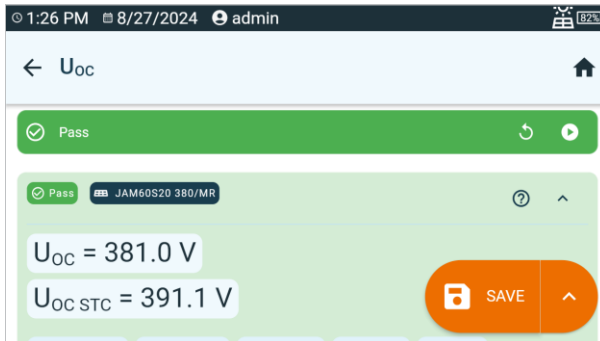

$U_{OC}$  – measured open circuit voltage

$U_{OC\,STC}$  – measured  $U_{OC}$  voltage converted to STC

$E_1$  – solar irradiance of the tested object no. 1

$E_2$  – solar irradiance of the tested object no. 2

$T_{PV1}$  – temperature of tested object no. 1

$T_{PV2}$  – temperature of tested object no. 2

4



Press **START** button to enable the result to be written to memory.

# 5

You may do the following with the measurement result:



ignore and exit to the measurement menu,  
repeat it (the selection window for the measurement you want to repeat will be shown),



**SAVE** – save to memory,



**SAVE AND ADD** – create a new folder/device which is equivalent to the folder/device where the result of the previously performed measurement was saved,



**SAVE TO THE PREVIOUS ONE** save the result in the folder/device where the result of the previously performed measurement was saved.



The result will not be assessed if:

- it has not been converted to Standard Test Conditions (STC),
- the measurement was performed without selecting the type of photovoltaic panel.

# 8 Automatical tests

## 8.1 Performing automatic measurements

In this mode, readiness for the next measurement occurs without the need of returning to the menu.

1



Go to the **Procedure** section.

2



- Select the appropriate procedure from the list. You can use the browser for assistance.
- By touching the name label you can display its properties.

3



Enter the procedure. Here you can:

Set how the procedure will be performed.

- **Fully automatic** (✓ **Auto**) – every subsequent test will be executed without the need for the user's approval (provided that the previous test result is positive),
- **Semiautomatic** (Auto) – upon completing each test the tester will stop the sequence and the readiness for the next test will be indicated on screen. Commencing subsequent test will require pressing **START** button,

**Multibox** enable or disable the **Multibox** function. See also **sec. 8.3** ,



change the settings of stages (component measurements) of the procedure. See also **sec. 2.3** ,



display the properties of the procedure,



edit the procedure as in **sec. 8.2**, i.e.:



change stage settings,



change the order of stages,



delete stages,



add further stages,



save the procedure.

4



Press **START** button.



If the **Multibox** is turned on, perform the desired number of measurements for each of the measured values. Then proceed to measure the next quantity.

The test will continue **until all measurements are completed** or until the user presses



Touching the bar with the result reveals partial results.

5

After the measurement is completed, you can read the result. Touching the bar with the result will now also reveal partial results.

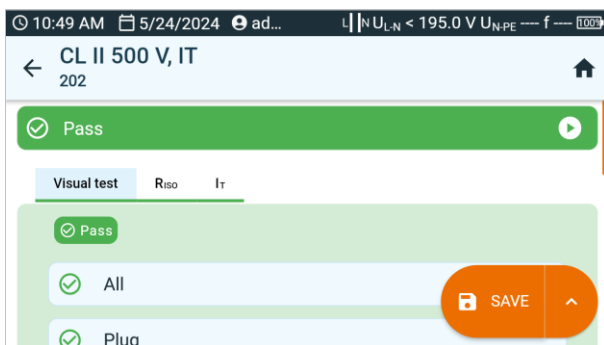

6

You may do the following with the measurement results:



ignore and exit to the measurement menu,



repeat it (the selection window for the measurement you want to repeat will be shown),



**SAVE** – save to memory,



▶ **SAVE AND ADD** – create a new folder/device which is equivalent to the folder/device where the result of the previously performed measurement was saved,



▶ **SAVE TO THE PREVIOUS ONE** save the result in the folder/device where the result of the previously performed measurement was saved.

## 8.2 Creating measurement procedures

1



Go to the **Procedure** section.

2



Add a new procedure. Enter its name and ID.

3







- Add stages (component measurements).
- Tap an item to select it. Tap it again to deselect it.
- Confirm the stage list.

4





Now you can:

-  change stage settings,
-  change the order of stages,
-  delete stages,
-  add further stages,
-  save the procedure.

## 8.3 Multibox function

The Multibox function is disabled by default (Multibox). Use **Soneil PAT Analysis** software to permanently enable an user procedure.

Enabling this function (√ **Multibox**) allows the user to perform multiple measurements of the parameter – except for power. The function is especially useful in situations when multiple measurements in a single object are required.

- Each measurement of the same parameter is treated as separate.
- Another measurement of the same parameter is started with  icon.
- To enter the measurement of the next value press  icon.
- All results are saved to memory.

Measuring circuit for each test is the same as for its corresponding manual measurement.



The function is not supported by photovoltaic procedures.

## 8.4 Guidelines

### 8.4.1 Photovoltaics (DC)



#### WARNING

- Before testing the object, restrict access to it by unauthorized persons.
- Do not touch any metal parts of the photovoltaic system and the back of the modules during the measurement.
- During measurements of insulation resistance, dangerous voltage is present at the ends of test leads of the meter.
- It is forbidden to disconnect test leads and to change the position of the function switch before completion of measurement. Failure to obey the above instruction will lead to high voltage electric shock and make it impossible to discharge the tested object.



#### NOTE!

During the measurement, the photovoltaic system is short-circuited for a short time. The test leads must not be disconnected during the measurement - there is a risk of electric arc ignition and damage to the meter.



- The meter emits a continuous audio signal until test voltage reaches 90% of the preset value (and also when 110% of the preset value is exceeded).
- During the measurement, the meter generates a beep every five seconds - it facilitates capturing time parameters.
- After completion of measurement, the capacitance of the object tested is discharged by shorting + and - terminals.



## 9 Special features

### 9.1 $R_{ISO}$ graphs

1a



During the  $R_{ISO}$  measurement, it is possible to display the graph. Using the options on the top bar, you can display:

- a graph for the required pair of wires,
- the data set to be presented.

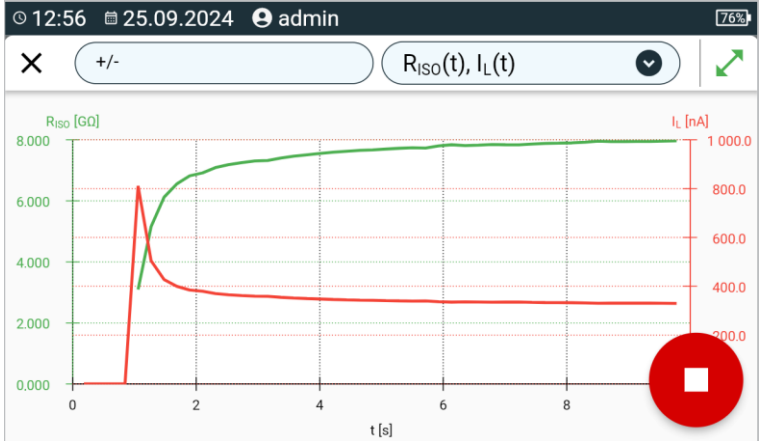

1b



You can also open the graph after the measurement is finished.

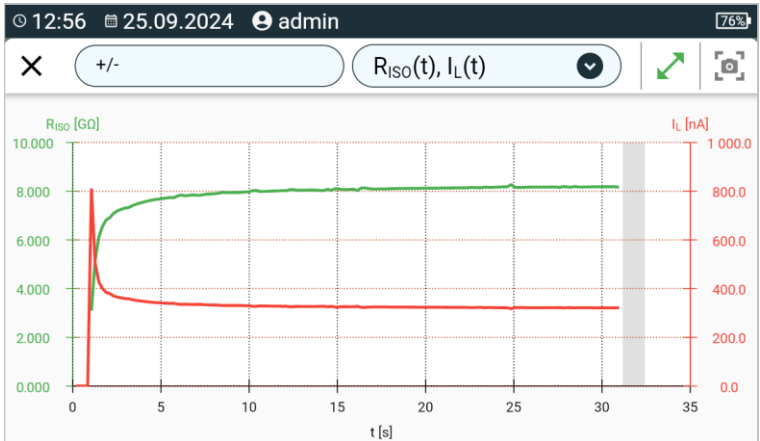





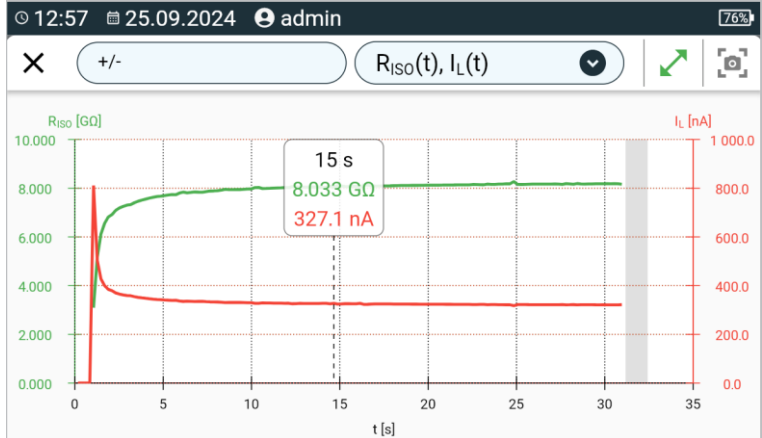



W During or after the measurement, you can display or hide the sub-result for a given second of the test. To do this, simply touch the point on the graph that interests you.



#### Description of function icons

- 
 Marking the measured pair of conductors. If a measurement is in progress, only the currently measured pair is available
- 
 Fitting the entire graph on the screen
- 
 Scrolling the graph horizontally
- 
 Extending the graph horizontally / vertically
- 
 Narrowing the graph horizontally / vertically
- 
 Return to the measurement screen

## 9.2 Correcting the $R_{ISO}$ value to the reference temperature

The meter has the ability to convert the  $R_{ISO}$  measurement value to resistance values at reference temperatures acc. to the ANSI/NETA ATS-2009 standard. To obtain these results, the user has to:

- enter the temperature value manually or
- connect the temperature probe to the instrument.

The following options are available:

- $R_{ISO}$  converted to a value at 20°C for oil insulation ((applies i.e. to insulation in cables),
- $R_{ISO}$  converted to a value at 20°C for solid insulation (applies i.e. to insulation in cables),
- $R_{ISO}$  converted to a value at 40°C for oil insulation (applies i.e. to insulation in rotating machinery),
- $R_{ISO}$  converted to a value at 40°C for solid insulation (applies i.e. to insulation in rotating machinery).

### 9.2.1 Correction without the temperature probe

1



Perform the measurement.

2



Save the result in the memory

3



Go to this result in the memory of the meter.

4

Enter the temperature of the tested object and the type of its insulation. Then the meter will convert the measured resistance into the resistance at the reference temperature: 20°C ( $R_{ISO\ k20}$ ) and 40°C ( $R_{ISO\ k40}$ ).



2:00 PM 9/26/2024 admin 55%

× Temperature coefficient

T  °C

✓  $R_{ISO} = 8.187\text{ G}\Omega$  T = 30°C

$R_{ISO\ k20} = 12.9\text{G}\Omega$   $R_{ISO\ k40} = 5.2\text{G}\Omega$



To obtain a temperature reading, you can also connect a temperature probe to the meter and enter its reading. See **sec. 9.2.2, step 1**.

## 9.2.2 Correction with the temperature probe



### WARNING

To ensure user safety, it is not allowed to mount the temperature probe on objects with voltage higher than 50 V to earth. It is advisable to ground the examined object before mounting the probe.

- 1 Connect the temperature probe to the meter. The temperature measured by the instrument is displayed at the top of the screen.

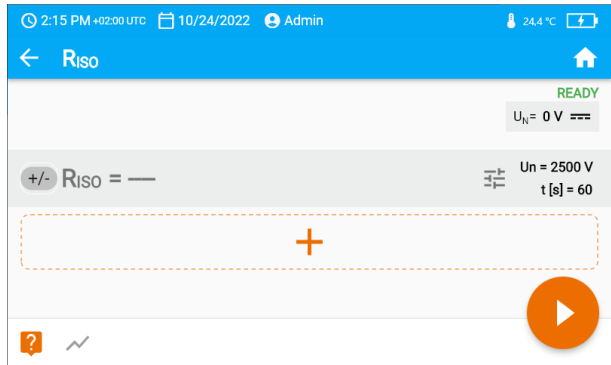
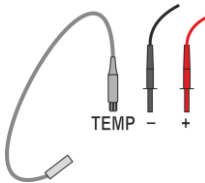

2



Perform the measurement.

3



Save the result in the memory

4



Go to this result in the memory of the meter.

# 5

Enter the type of insulation of the tested object; the temperature at which the measurement was performed will be stored in the memory and cannot be changed. The meter will convert the measured resistance into the resistance at the reference temperature: 20°C ( $R_{ISO\ k20}$ ) and 40°C ( $R_{ISO\ k40}$ ).



× Temperature		
temperature	Type of insulation	
24.4 °C	solid	
⌚ <b>R<sub>ISO</sub> = 9.973 GΩ</b>		T = 24.4°C
R <sub>ISO k20</sub> = 12.5GΩ	R <sub>ISO k40</sub> = 5GΩ	



You will change the temperature unit by following **sec. 1.5.5**.

## 9.3 Correction of results to STC

The function is used to convert the measurement results to STC (*Standard Test Conditions* – reference conditions, for which the manufacturer provides all the parameters of the PV modules). For this purpose, readings from at least one IRM-1 meter are required. The conversion takes place only when the solar radiation indicated by IRM-1 is at least 100 W/m<sup>2</sup>.



To communicate with IRM-1, a communication adapter must be connected to the socket  on the master meter.

### 9.3.1 Connectivity between IRM-1 and the meter

If IRM-1 meters have been paired with the instrument, this one searches for them when turned on. When IRM-1 is found, a connection is established and the screen shows . The instrument remembers the last 2 paired IRM-1's.

The following symbols may appear under each item in the list.

 – IRM-1 not paired with the meter.

 – IRM-1 paired with the meter.

 – IRM-1 reference (master).

### 9.3.2 Pairing the meters

If the pairing with the IRM-1 has not been made, it should be done as indicated below.

1

**PAIR**

Turn on the IRM-1 meter to be paired. Set it to pairing mode.



2



Go to **Settings** ► **Accessories** ► **IRM**. A list of detected IRM-1 meters will be displayed.



3



Go to the settings of the desired IRM-1 and select **Link**. If the selected IRM-1 is the first of the paired devices, the symbol  will appear at the top of the meter screen.

### 9.3.3 Unpairing

1



Go to **Settings** ► **Accessories** ► **IRM**. A list of detected IRM-1 meters will be displayed.



2



Go to the settings of the desired IRM-1 and select **Unlink**. If the selected IRM-1 is the last of the unpaired devices, the symbol will disappear from the top of the meter screen. 

### 9.3.4 Correction of IRM indications

If the IRM-1 meters differ in their readings, they must be corrected to the readings of the reference (master) IRM-1. The correction must be performed for both meters at the same measuring point. Both must be mounted in the same direction and at the same angle (e.g. one above the other on the same PV panel).



1 Pair temperature and sunlight meters with your device.

2  Select **Correction IRM-1**.

3  $E_1 \neq E_2$   
 If the  $E_1$  and  $E_2$  values differ, correct the readings by pressing **START**. Once the procedure is complete, a message will appear saying that correction has been enabled.

4  You can also compare temperature and sunlight readings in the **Environmental measurements** function.



The correction remains in effect until the PVM meter is turned off.



## 9.4 Current readings of environmental parameters

This function allows for simultaneous reading of parameters from all solar radiation and temperature meters that are currently connected to the device.

1 Pair temperature and sunlight meters with your device.

2  Select **Environmental measurements**.



	IRM-1 (L22634)	IRM-1 (L27523)
$E_i$ [W/m <sup>2</sup> ]	900	900
$T_{PV1}$ [°C]	45.0	45.0
$T_{A1}$ [°C]	25.0	25.0
$\odot$ [°]	270	270
$\sphericalangle$ [°]	45	45

$E_i$  – irradiance

$T_{PV}$  – temperature of the PV module

$T_A$  – ambient temperature

$\odot$  – angle of deviation from the north.

$\sphericalangle$  – inclination of the meter in relation to the reference angle.

3  If the readings at the same measuring point differ, you must correct the readings – see **sec. 9.3.4**.

4  If you want to save the current readings, press the **START** button.

5 You may do the following with the measurement result:



ignore and exit to the measurement menu,



repeat it (the selection window for the measurement you want to repeat will be shown),



**SAVE** – save to memory,



▶  **SAVE AND ADD** – create a new folder/device which is equivalent to the folder/device where the result of the previously performed measurement was saved,



▶  **SAVE TO THE PREVIOUS ONE** save the result in the folder/device where the result of the previously performed measurement was saved.

## 9.5 Label printing

1



Connect the printer to the meter (**sec. 9.5.1**).

2



Enter printing settings (**sec. 9.5.2**).

3



Perform the measurement.

4



Print the report label (**sec. 9.5.3**).

### 9.5.1 Connecting the printer

#### 9.5.1.1 Wire connection

1



Connect the printer to one of the USB Host sockets.

2



The printer is visible in **Settings ▶ Accessories**.

#### 9.5.1.2 Wireless connection

1



Turn on the printer and wait until it starts broadcasting its Wi-Fi network.

2



In the meter go to **Settings ▶ Meter ▶ Communication ▶ Wi-Fi**.

3



Select the network broadcast by the printer. The printer will connect to the meter within 90 seconds.

4



The printer is visible in **Settings ▶ Accessories**.

## 9.5.2 Printing settings

1









Go to **Settings** ► **Accessories** ► **Printing**.

2



Enter the **common printing settings**. Here you can set:

- **QR code type**
  - **Standard** – stores all information about the tested device: identifier, name, measurement procedure number, technical data, location in memory, etc.
  - **Shortened** – stores only the ID of the tested device and its location in the meter's memory.
- **Properties of automatic printouts**
  - **Print automatically after measurement** – automatic printing after the test is completed.
  - **Folding label** – a label with a mark that makes it easier to wrap the label on the cable.
  - **Object label** – label with the device test result.
  - **Label of related objects** – a label with the test result of the device and the object related to it (e.g. IEC power cable).
  - **RCD label** – a label with the RCD test result.
- **Print lines indicating number of months before next tests should be performed.** Printing lines on the left, right or both sides of the label depending on the number of months after which another device test should be performed. For example:
  -  [3] – the line on the left side of the printout indicates a 3-month cycle.
  -  [6] – the line on the right side of the printout indicates a 6-month cycle.
  -  [12] – the line on the left and right side of the printout indicates a 12-month cycle.
  -  [0]  [0]  [0] – no line variant is printed, which means a non-standard cycle.
- **Additional label description** – annotation entered manually by the user.

# 3



Enter **printer-specific settings**. Here you can set:

- **Object label format**
  - **Detailed** – contains a list of questions of the visual examination together with the assessment and the results of individual measurements with the assessment.
  - **Standard** – includes overall result of the test, logos and additional data (name of the device, measuring person).
  - **Shorted** – similar to standard format but without the logo and additional information.
  - **Mini** – only the identifier, name and QR code of the tested device are printed.
- **Other settings**
  - **Additional label description** – whether to include it or not.
  - **Measurement comment** – include it or not.
- **Description of the tested object** – include it or not.









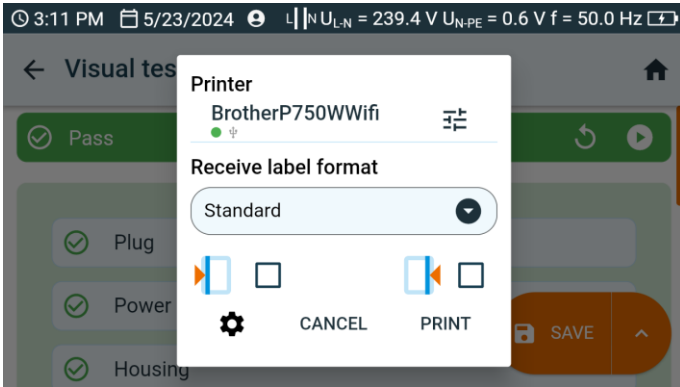



Settings can be changed through **Sonel PAT Analysis** software, after connecting the tester to PC.



### 9.5.3 Printing a label with the report



Printing may be performed in several cases: When the **Print Label** window is shown, check the box corresponding to the selected device testing period (see **sec. 9.5.2** ).



- a**   
- When browsing the memory – after adding a newly purchased device (not tested yet) with factory security confirmation. Such a memory cell does not contain measurement results, but it contains identification data and device parameters (if they have been entered). Select icon . Before you print the label using the **PRINT** command, you can:
- change the printer settings ()
  - choose label format,
  - change the common printing settings ().
- In this case, the label will indicate that the next test of the device should be performed after **6 months**.

- b**  
- When viewing memory. If you have entered a cell containing data, select icon . Before you print the label using the **PRINT** command, you can:
- change the printer settings ()
  - choose label format,
  - change the common printing settings ().

- c**  
- After completing a single measurement. Select **SAVE**. If the **Print automatically after measurement** (**sec. 9.5.2** ) option is:
- active, the label is printed immediately,
  - inactive, the meter will ask about printing.

- d**  
- After completing the measurement in automatic mode. When the result is presented, the meter will ask about printing.

# 10 Resources

## 10.1 Photovoltaic panels database

PV installations are defined by the technical parameters of their components. This is where you'll store them.

1



Go to **Resources** ► **PV Panels**.

2

You can edit and browse the database. Designations:



Object added to Favourites



Predefined characteristics



User characteristics

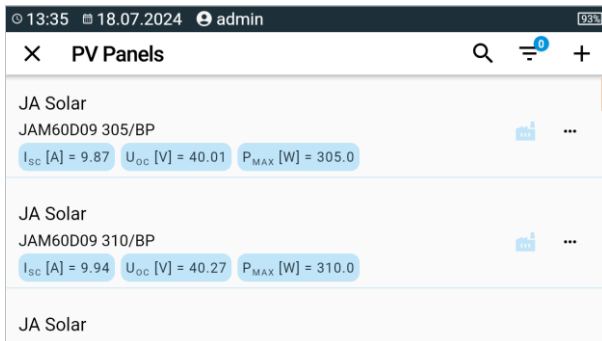

Object search



Clearing the search bar



Filtering results



Here you can add a new PV panel and enter its data



More options for the object



Add the object to your favourites



Object details



Editing the object



Deleting the object

# 11 Memory of the meter

## 11.1 Memory structure and management

The memory of measurement results is in a tree structure. It consists of parent folders (maximum 100) in which child objects are nested (maximum 100). The number of these objects is unlimited. Each of them has sub-objects. The maximum total number of measurements is 9999.

Viewing and managing the memory structure is very simple and intuitive – see the tree below.



Add new:



folder



instrument



measurement (and go to the measurement menu to select and take a measurement)



Enter the object and:



show options



show object details



edit details of the object (enter/edit its characteristics)



Select the object and:





select all objects



delete selected objects



- In the memory menu you can see how many folders (  ) and measurement results (  ) are present in a given object.
- When the number of results in the memory reaches the maximum, saving the next one is only possible provided by overwriting the oldest result. In this situation, the meter will display an appropriate warning before saving.



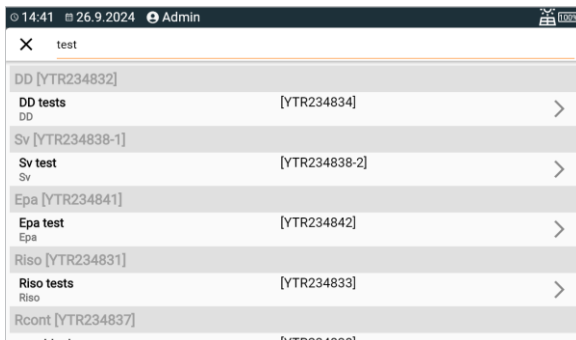

## 11.2 Search function

To find the desired folder or object faster, use the search function. After selecting icon  , simply enter the name of what you are looking for and tap on the appropriate result to proceed.













## 11.3 Saving measurement result data to the memory

You can save measurements in two ways:









- by performing a measurement and then assigning it to an object in the memory structure ()
- by entering an object in the memory structure and making a measurement from this level (  ).

However, you won't save them directly to parent folders. You will need to create a child folder for them.

### 11.3.1 From the measurement result to the object in memory

-  End the measurement or wait for it to be completed.
-  Save the result in the memory (**SAVE**).  
  Create a new folder/device which is equivalent to the folder/device where the result of the previously performed measurement was saved (**SAVE AND ADD**).  
  Save the result in the folder/device where the result of the previously performed measurement was saved (**SAVE TO THE PREVIOUS ONE**).
-   L  
  If you have selected the **SAVE** option, the window for selecting the save location selection window will open. Select the right one and save the result in it.

### 11.3.2 From the object in memory to the measurement result

-   L In the meter's memory, go to the location where the results are to be saved.
-    Select the measurement you want to perform
-    Perform the measurement.
-  Save the result in the memory.



## 12 Software update

1 Download the update file from the manufacturer's website.

2 Save the update file to a USB stick. The stick must be formatted as a FAT32 file system.

3  Turn the meter on.

4  Enter **Settings**.

5   
 Go to **Meter ► Update**.

6  Insert the USB stick into the port of the meter.

7  Select **UPDATE (USB)**.

8 Watch the update progress. Wait until it's finished. You will be informed about the update result with an appropriate message.



- Before starting the update, charge the meter battery to 100%.
- The update will start if the software version on the USB stick is newer than the version currently installed on the meter.
- Do not turn off the meter while the update is in progress.
- During the update, the meter may turn off and on automatically.

## 13 Troubleshooting

Before sending the instrument for repairs, contact our service department. It maybe possible that the meter is not damaged, and the problem has been caused by some other reasons.







The meter can only be repaired at outlets authorized by the manufacturer.

Troubleshooting of typical problems during the use of the meter is described in the table below.





Symptom	Action
The meter does not turn on.	Charge the batteries or switch to mains power operation.
No battery charging despite mains power connected.	Warm up or cool down the meter so that its temperature is within the permissible range for battery charging.
Incorrect measurement result after moving the meter from a cold environment to a warm environment with high humidity.	Do not take measurements until the meter dries or reaches ambient temperature. It is recommended to acclimatize the meter in a closed housing to avoid condensation on internal electronic components.
Error <b>ID_VALUE_ERROR_SAFETY_LOCK</b> .	PV circuit failure. Send the instrument to the service centre.
Message <b>Meter damaged. Risk of electric arc ignition</b> .	Disconnect the meter from the tested object in a <b>quick and decisive way</b> to minimize the ignition of the electric arc between the disconnected elements. Send the instrument to the service centre.
No results in the I-U curve measurement.	Too much capacitance on the measurement terminals. Check the tested object and connect the meter to it in a different way.
There are problems with saving or reading measurements.	Optimize the meter's memory ( <b>sec. 1.5.7</b> ).
There are problems navigating through folders.	
Repairing the meter's memory did not bring the expected results.	Reset the meter's memory ( <b>sec. 1.5.7</b> ).
There are problems preventing the use of memory.	
Operation of the meter is noticeably slower: long response to touching the screen, delays when navigating through the menu, long saving to memory, etc.	Reset the meter to the factory settings ( <b>sec. 1.5.7</b> ).
Error code.	Turn the meter off and on. If the error continues to occur, send the instrument to the service center.
<b>FATAL ERROR</b> message and error code.	Contact the customer service centre and provide the error code to get help.
The meter does not respond to user actions.	Press and hold the <b>ⓘ</b> button for ca. 7 seconds to turn off the meter.

# 14 Additional information displayed by the meter













## 14.1 Electrical safety

	<ul style="list-style-type: none"> <li>• Test voltage is present on terminals of the meter.</li> <li>• The tested object is currently undergoing charging or discharging.</li> </ul>
	Insulation breakdown.
 <b>NOISE</b>	Interference voltage of more than 25 V DC but less than 50 V DC is present on the tested object. Measurement is possible but may be burdened with additional error.
 <b>LIMIT I</b>	Activation of current limit. The symbol displayed is accompanied by a continuous beep.
 <b>HILE</b>	Breakdown of the tested object insulation, the measurement is interrupted. The message appears after <b>LIMIT I</b> displaying for 20 s during the measurement, when the voltage previously reached the nominal value.
 <b>UDET</b> <b>U<sub>N</sub>&gt;50 V</b>	<p>Dangerous voltage on the object. The measurement will not be performed. In addition to the displayed information:</p> <ul style="list-style-type: none"> <li>• U<sub>N</sub> voltage value at the object is displayed,</li> <li>• a two-tone beep is generated,</li> <li>• red LED flashes.</li> </ul>
 <b>DISCHARGING</b>	Discharging the object in progress.

## 14.2 Safety of electrical equipment

<b>Voltage on the meter!</b>	Voltage $U_{N-PE} > 25 \text{ V}$ or lack of PE continuity, measurements are blocked.
<b>Too high U L-N!</b>	Mains voltage $> 265 \text{ V}$ , measurements are blocked.
	Correct polarity of power supply (L and N), measurements possible.
	Incorrect polarity of power supply, swapped L and N in the power supply socket of the tester. The meter automatically swaps L and N in the test socket – measurements are possible.
	Lack of continuity in conductor L.
	Lack of continuity in conductor N.
	Short circuit of L and N wires.

## 14.3 Photovoltaics

 <b>Incorrect polarity!</b>	<p>The test leads are interchanged with each other. Connect them correctly.</p>
	<ul style="list-style-type: none"> <li>• Test voltage is present on terminals of the meter.</li> <li>• The tested object is currently undergoing charging or discharging.</li> </ul>
 <b>Meter damaged. Risk of electric arc ignition.</b>	<ul style="list-style-type: none"> <li>• Risk of electric arc ignition.</li> <li>• Damage to the IGBT transistor and the main relay.</li> </ul> <p>Disconnect the meter from the tested object <b>in a quick and decisive way</b> to minimize the ignition of the electric arc between the disconnected elements. Send the instrument to the service centre.</p>
 <b>HILE</b>	<p>Breakdown of the tested object insulation, the measurement is interrupted. The message appears after <b>LIMIT I</b> displaying for 20 s during the measurement, when the voltage previously reached the nominal value.</p>
 <b>UDET</b>	<p>Dangerous voltage on the object. The measurement will not be performed. In addition to the displayed information:</p> <ul style="list-style-type: none"> <li>• U voltage value at the object is displayed,</li> <li>• a two-tone beep is generated,</li> <li>• red LED flashes.</li> </ul>
	<p>Meter temperature is too high. Cease measurements and wait for the meter to cool down.</p>
 <b>LIMIT I</b>	<ul style="list-style-type: none"> <li>• Activation of current limit.</li> <li>• Capacitance of the tested object is too high.</li> <li>• The symbol displayed is accompanied by a continuous beep.</li> </ul>
<b>I<sub>SC</sub> &gt; 40.00 A</b>	<p>I<sub>SC</sub> current of the tested object is too high. Check the tested object and connect the meter to it in a different way.</p>
 <b>NOISE</b>	<p>Interference voltage is present on the tested object. Measurement is possible but may be burdened with additional error.</p>
 <b>DISCHARGING</b>	<p>Discharging the object in progress.</p>
	<p>Test leads reversed or reverse polarity. The measurement is blocked.</p>
	<p>Damage – short circuit in the tested object.</p>
	<p>Damage – lack of continuity of the tested object.</p>
	<p>Measuring range is exceeded.</p>
<b>E<sub>1</sub> &lt; 700 W/m<sup>2</sup></b>	<p>The solar radiation value is lower than recommended by the IEC 61829 standard.</p> <ul style="list-style-type: none"> <li>• At solar radiation levels between 100...699.9 W/m<sup>2</sup> the results are converted to STC.</li> <li>• At solar radiation levels between 0...99.9 W/m<sup>2</sup> the results are not converted to STC.</li> </ul>

<b><math>E_1 \neq E_2</math> [&gt;2%]</b>	Solar irradiance (E) differs by more than 2%.
<b><math>T_{PV1} \neq T_{PV2}</math> [&gt;1°C]</b>	Temperature of PV cells ( $T_{PV}$ ) differs by more than 1°C.
<b>IRM-1<sub>1</sub> [X]</b>	No connection to the reference (master) IRM-1 device.
<b>IRM-1<sub>2</sub> [X]</b>	No connection to auxiliary IRM-1 device.
<b>IRM-1<sub>1</sub> [X]   IRM-1<sub>2</sub> [X]</b>	No connection to IRM-1 devices.

## 15 Manufacturer

The manufacturer of the device and provider of guarantee and post-guarantee service:

**SONEL S.A.**

Wokulskiego 11

58-100 Świdnica

Poland

tel. +48 74 884 10 53 (Customer Service)

e-mail: [customerservice@sonel.com](mailto:customerservice@sonel.com)

web page: [www.sonel.com](http://www.sonel.com)





**SONEL S.A.**

Wokulskiego 11  
58-100 Świdnica  
Poland

**Customer Service**

tel. +48 74 884 10 53  
e-mail: [customerservice@sonel.com](mailto:customerservice@sonel.com)

[www.sonel.com](http://www.sonel.com)